

spex[®]

Shaping Better Lives



**CLINICAL
WHEELCHAIR
SEATING**



Designed and
manufactured by **medifab[®]**

[SPEXSEATING.COM](https://www.splexseating.com)

medifab[®]

Shaping
better lives
since 1990.



Grown from small beginnings, the Medifab story is driven by a single-minded purpose – to bring comfort and functionality to people living with disabilities.

Built from the ground up by a New Zealand family, we design, manufacture and export specialist seating and high-quality clinical equipment for children and adults with complex medical needs.

Established in 1990 with a genuine passion to help, we innovate to create break-through technologies, so our clients can manage their daily physical and cognitive challenges with the dignity they deserve.

Working closely with therapists, carers and clients, our customer-focussed approach and 'whatever it takes' attitude is at the heart of everything we do. And now, as a leading manufacturer and supplier of high-quality clinical equipment, we continue to push boundaries and adapt our solutions so we can shape better lives throughout the world.

Driven to make a positive difference

Our vision is to make a positive difference to people living with disabilities, along with the carers and therapists that support them. By combining innovative designs with depth of industry know-how, we design, manufacture and supply break-through postural support solutions for people living with a range of special needs and complex disability.

Revolutionising the postural aid world

Disrupting the current customary, moulded seating industry for the better, Spex is the world's first customisable and adjustable seating system for wheelchairs and pushchairs.

By combining innovative, creative thinking with a thorough clinical evaluation, we developed a fully customisable seating system produced from our state-of-the-art manufacturing facility in Canterbury, so our clients would never have to compromise on comfort again.

Transforming lives with technical innovations

Featuring specialist adjustable foam components and highly engineered hardware, Spex Seating is designed to mould to the individual's shape, promoting postural integrity and pressure relief.

A technical innovation that's disrupted the conventional moulded seating industry, this fully adjustable system allows carers and therapists to customise Spex to their client's individual postural needs, making daily discomfort a thing of the past.

Taking Spex global

We developed a modular approach to manufacturing, so therapists anywhere in the world can solve complex postural problems on the spot with Spex Seating.

With registered worldwide patents and internationally recognised certifications that prove Spex meets rigorous quality standards, this break-through technology adds a completely new dimension to postural support and comfort.

Bringing clinical comfort to the world

Our goal to improve the lives of people globally through exporting Spex inspired us to strengthen our logistical capabilities and elevate procedures to meet the rigorous standards global authorities recognise and trust.

Given the innovative nature of Spex, we've partnered with world-class ISO accredited Third Party Logistics centres in Europe and North America, so we can deliver timely.

Internationally recognised for quality

Having established a quality and regulatory affairs department, and a culture focused on quality and continuous improvement, we have achieved ISO registration for 9001 Quality Management System, 14001 Environmental Management System and 13485 Medical Devices – the internationally recognised standard that guides medical device manufacturers in implementing quality management systems.

These certifications combined with our comprehensive logistics network enable us to distribute to Australia, Europe, parts of Asia and the rest of the world.

Distributing Spex to the world

With a solid and comprehensive export network in place, and internationally recognised certifications to our name, we can export Spex Seating to international markets and shape better lives in every corner of the world.

Shaping better
lives worldwide
through clinically
proven modular
wheelchair
seating.



Contents

| | |
|---|----|
| Spex [®] Adjustable Stroller Seating | 6 |
| Spex [®] Discovery Stroller | 8 |
| Spex [®] Wonderseat Stroller | 12 |
| Spex [®] - Our Heritage | 16 |
| Vigour Cushion | 20 |
| Spex [®] Standard Contour Cushion | 21 |
| Spex [®] High Contour Cushion | 22 |
| Spex [®] SuperHigh Contour Cushion | 24 |
| Spex [®] Flex Cushion | 26 |
| Spex [®] Back Support Hardware Options | 29 |
| Vigour Back Support | 30 |
| Height-Adjustable Back Support | 32 |
| Mantaray Back Support | 34 |
| Comfi Back Support | 36 |
| Spex [®] Back Support | 38 |
| Contouring the Spex Back Support Surface | 40 |
| Back Support Contouring Cubes | 41 |
| SuperShape™ Back Support | 42 |
| Tessellated Positioning Kit | 46 |
| Spex [®] Wheelchair Padding | 47 |
| Lateral Trunk Supports | 48 |
| Lateral Support Pads | 50 |
| Transport Certified | 52 |
| Grid-Base Seat Pan | 53 |
| Medial Thigh Support | 54 |
| Head Support | 55 |
| Lateral Thigh Supports | 56 |
| Arm Supports | 56 |
| Anterior Trunk & Pelvic Positioning Tips | 58 |
| Anterior Trunk Positioning | 59 |
| Anterior Pelvic Positioning | 60 |
| Limb Stabilisers | 61 |
| Break the Mould! | 62 |
| About Medifab | 63 |

spex[®]

Paediatric Seating &
Mobility Solutions.



Our mission is to enable parents to lead a dynamic, fun and active lifestyle. Gain peace of mind knowing your child's special needs are cared for with clinical and ergonomic support for the best start in life!



spex® | Discovery

Our philosophy is to care for the child right throughout the day within one seat, that's why the Discovery seat can be interfaced into any of the 4 bases saving on resources and the need to purchase additional equipment.

Designed especially for infants and toddlers between 5 months to 5 years, the Discovery seating system allows the therapist to optimise the postural care of children from a young age and helps to address and prevent clinically challenging issues before they become a problem.



spex® | Wonderseat

Introducing the latest innovation from the designers of the revolutionary Spex seating system – the Spex Wonderseat. Spex clinical seating technology as developed originally for wheelchairs is now available with one of the world's leading rehabilitation strollers, the Bingo OT.

A special edition of Spex seating has been carefully developed so therapists can now provide more comfort and superior positioning for young children with complex seating needs with the freedom of a stroller rather than a wheelchair.

spex® | Discovery Stroller

Our mission is to enable parents to lead a dynamic, fun and active lifestyle. Gain peace of mind knowing your child's special needs are cared for with clinical and ergonomic support for the best start in life!

CLINICAL CARE WITH STYLE



Observes internationally recognised **clinical and therapeutic practices** for disabled or handicapped children.

Ability to be **simple or complex** depending on user needs.

Provides quality postural management with **modular accessories** that can be added and removed depending on specific needs.

Provides specific **fine-tuned seating** requirements for a perfect setup for the individual user.

Delivers an **optimal seated position** so the child can engage in functional activities.

CLINICAL ADVANTAGES

- Provides a stable surface to facilitate normal movement patterns which are essential to promote function.
- Modular seating accessories provide postural management that is essential to prevent, accommodate or correct skeletal deformities, and normalise tone.
- Active combination of the seating functions includes tilt, elevating legrest and reclining backrest. These manage pressure, promote comfort and relaxation, enhance automatic nervous system function, decrease fatigue and promote increased tolerance of the desired posture.
- The seating unit combined with Verve base, modular accessories and restraints makes Discovery a premium stroller that promotes stabilisation of the pelvis and trunk, allows the hands and upper extremities to be free, facilitates the manipulation of objects and increases learning opportunities and interaction with the infant's environment.



MODULAR CONFIGURATION



Depending on what needs the child has, the seat can be easily configured.

SMOOTH TILT



Tilt range from 90° to 40°. Unique function is an integrated part of the seat so regardless of what base you choose, the seating position is maintained as the therapist intends. Mechanism is amalgamated into seat unit so there are less moving parts.

BACK SUPPORT RECLINE



Recline can be positioned and locked at any position 90° to 160°. Ergonomic and biomechanical system that reduces skin shear when in use.

| Code | Seat Depth | Seat Width | Lower Leg Length | Backrest Height | Shoulder Strap Height | Backrest Recline | Trunk Lateral Width | Seat Tilt-In-Space | Max Seat Load |
|---------------|------------|------------|------------------|-----------------|-----------------------|------------------|---------------------|--------------------|---------------|
| 2006-0010-000 | 13-30 cm | 13-27 cm | 14-28 cm | 45-58 cm | 24-39 cm | 90-160° | 12-25 cm | 0-40° | 25 kg |

spex® | Discovery

One seat, many applications



EXPLORE

Verve

Look smart outdoors with this ultra-stylish, lightweight stroller

2006-0040-000



FUN FAMILY TIME

Hi-Lo Indoor Base

Choose up or down with this hi-lo feeding and activity base

Manual: 2006-0016-000

Electric: 2006-0018-000



LEARN & PLAY

Lunar

Interact with friends with this adjustable base

2006-0013-000

RELAX & REST

Moon Rock

Stimulation base to put the fun into sitting

2006-0014-000

FOOTPLATE ELEVATION

Functions with true biomechanical movement with pivot located near the knee. Adjustment knob is located at rear of seat to ensure there are no harmful parts between the child and the footrest.

BACK SUPPORT

The height adjustable back support with padded lateral supports provides stability and comfort. Optional sacral pad can be added to the padding to encourage an optimum pelvis position.

REMOVABLE COVERS

All covers are removable, machine washable and promote air circulation keeping the child cool and dry. Optional wipe down covers available.



spex® | Discovery Verve Base

Verve has a stunning style for exploring indoor and outdoor spaces and places. Verve is light weight, easy to manoeuvre and fold. The simple but unique mounting system allows the Discovery seat to be mounted in a forward or a rear facing position.

SLICK URBAN DESIGN

Feather-light handling in **single** or **inline** mode

Dual front wheel suspension system with **airless tyres**



Sleek urban styling with four wheels

Ultra-adaptable, compact, auto-lock fold that stands upright

FORWARD OR REAR FACING

The seat can be installed to face the carer or face the world!



ONE OR TWO!

If you are planning to have another child or already have one, the Verve Base has a sibling seat accessory available to enable the carer to push two children. Under no circumstances should the second seat be used in a motor vehicle.



HANDLE BRAKE AT FINGERTIPS

Push button in-handle braking system to stop and go with ease. 6 position adjustable handle height.

VERVE BUGGY SPECS

Push handle height: 77 - 109cm
 Frame width: 65cm
 Frame length: 93cm
 Front wheel diameter: 23.5cm
 Rear wheel diameter: 30cm
 Folded size: L84 x W65 x H31cm
 Weight (wheels incl.): 12.5kg
 Maximum load of main seat: 25kg
 Maximum load of sibling seat: 15kg
 Maximum load of Verve: 55kg

CHILLI

-022



OCEAN

-060



CALYPSO

-028



MANGO

-030



INK BLACK

Wipedown Covers

-209



spex® | Discovery Accessories

BENEFITS

- Inline functionality for go-anywhere style
- Sunhood and seat liner included
- Seat reclines for a snoozy baby!
- Safety tested to a maximum weight capacity of 25kg
- All weather protection with Verve double storm cover and double sun cover

COMPACT FOLDED SIZE

When folded, the frame is very compact. It can be locked for easy handling and the rear wheels are removable for better storage.



TRANSPORT CERTIFIED

When mounted on the Verve base, Spex Discovery complies with ISO 7176-19 for safe transportation in vehicles.



FUN & FRIENDLY

Parents will be empowered to enjoy life with Discovery's non-medical appearance.



Cushion Options
Standard flat & Adjustable modular postural cushion
2006-0611-XXX



Trunk Supports
Size 1 Teardrop: 2006-3110-XXX
Size 2 Teardrop: 2006-3120-XXX
Contoured: 2006-3030-XXX



Hip/Femur Control
Hip guides & Thigh guides,ommel
2006-1010-XXX



Head Supports
Adjustable: 2006-4460-XXX
Occipital: 2006-4101
Standard Lateral: 2006-4210
Extended Lateral: 2006-4301



Support Pads
Sacral pad: 2006-2510-100
Shoulder protraction wedge:
2006-2750-000



Sternum Harness
Not suitable for use with gastronomy tubes
2006-6751-027



5-Point Harness
Infant (on tee pad)
2006-6551-000



Pelvic Straps
2-point: 2006-6251-027
4-point: 2006-6420-027



Shoulder Harnesses
Shoulder/Crotch Strap: 2006-6516-027
Centrepoint Harness: 2006-6660-017



Limb Stabilisers
Feet: 2006-6060-000
Ankle: 2006-6151-000



Footplate Options
Dorsiflex wedge:
2006-5330-000
Neoprene protection cover:
(Standard) 2006-5305-000
(Extended) 2006-5335-000



Tray Options
Tray Table: 2006-7110-000
Padded Top: 2006-7450-000
Grab Rail: 2006-7510-000



Sun Canopy: 2006-7516-099



Weather Gear
Rain cover single: 2006-7620-000
Rain cover double: 2006-7622-000
UV shade single: 2006-7720-000
UV shade double: 2006-7722-000



Sibling Seat
2006-8670-000

spex® | Wonderseat Stroller

A breakthrough in rehabilitative stroller seating.

The Spex Wonderseat provides a solution for paediatrics that has never been seen before. For children with positioning needs where a stroller is the preferred option for the family, the Spex Wonderseat provides an optimum seating support designed to accommodate even the most challenging requirements!



Create clinical solutions with Spex cushion and back support system.



ALLOWANCE FOR HIP/THIGH FLEXION AND PRE-ISCIAL SUPPORT

A good pelvic foundation is paramount to assist in slowing, or even preventing pelvic and spinal asymmetries. Therefore, the cushion adjusts to correct or accommodate the child's pelvic and thigh needs.



SPEX POSITIONING CUSHION BASE

Strategic positioning pads can be added or removed from underneath the cushion to allow for different contours and shapes. This way we can meet the client's posture requirements present today; and readjust them in the future.



PELVIC OBLIQUITY BUILD-UP

Pelvic obliquity build-up can be achieved and easily adjusted on the cushion ischial well. Its adjustable pre-ischial area can be conformed on-the-spot for greater or lesser anti-thrust needs.



CREATE INSTANT SHAPE

Back support shaping allows for accommodation or correction of trunk spinal deformities, that will ultimately be supported through multi-adjustable lateral supports and anterior chest harnesses.



SPEX CONTOURING SYSTEM

Pockets behind the back-foam inner create a modular and adjustable solution for changing the contour to suit different user shapes and posture needs.



ASYMMETRICAL CONTOURING

Back support adjustable shaping can be easily adapted to meet common spinal deformities, such as Scoliosis, Lordosis, Kyphosis.

spex® | Wonderseat Stroller

A smart-looking stroller that enables parents to take their child outside and explore!



Adjustable suspension system.



COMFI HEAD SUPPORT

Ultimate comfort and positioning for the head with inbuilt lateral and occipital support. 2 styles available: standard lateral and extended lateral (shown).
Standard 2885-4241-XXX
Extended 2885-4341-XXX



Adjustable recline, seat tilt and elevating footplate.

SUPERIOR COMFORT AND STYLE

With a wide range of coloured seating options to choose from, the Spex Wonderseat offers a colour to suit any style. Stand out from the crowd in with our Chilli red or look pretty in pink with the Calypso.



OCEAN
-060



MANGO
-030



GRANITE
-090



CHILLI
-022



CALYPSO
-028

WONDERSEAT TECHNOLOGY

- Spex cushion
- Spex back support
- Axial® lateral supports
- Forearm supports

OPTIONS

- Hip belt positioning
- Shoulder harnesses
- Comfi head supports

FRAME AND SEAT FEATURES

- Bingo OT mobility base in matte black
- Open footrest platform
- Tray table

- Elevating legrest allowing for contractures 85°-160°
- Sun canopy

- Basket
- Transport tie-downs

- Oxygen bottle holder
- IV pole
- Weather gear

- Ventilator tray for respiratory equipment
- Feet sandals

- Height-adjustable indoor base
- Axial Pelvic Supports

spex® | Wonderseat User measurements

| Bingo Stroller Size | Size 1 | Size 2 | |
|------------------------------|-------------------------------------|---|---|
| Bingo Stroller Order Code | 3238-0010-032 | 3239-0010-032 | |
| Seating specs | A Hip width | 17-28cm (6.5-11") | 22-33cm (8.5-13") |
| | B Seat depth | 18-23cm (7-9") 1.1 Cushion 23-30cm (9-12") 1.2 Cushion | 23-33cm (9-13") 2.1 Cushion 28-38cm (11-15") 2.2 Cushion |
| | C Back height | 36-44cm (14-17") | 40-48cm (16-19") |
| | D Lower leg length* | 25-40cm (10-16") | 25-45cm (10-18") |
| | E Trunk lateral width | 12-28cm (5-11") | 15-30cm (6-12") |
| | F Trunk lateral height | 15-34cm (6-13.5") | 17-40cm (6.5-16") |
| | G Arm support height | 15-22cm (6-8.5") | 15-22cm (6-8.5") |
| | H Internal arm support width | 20-32cm (8-13") | 28-38cm (11-15") |
| | I Head support height | 45-65cm (18-25.5") | 50-70cm (20-28") |
| | J Cushion total width | 33cm (13") Size 1.1 33cm (13") Size 1.2 | 38cm (15") Size 2.1 38cm (15") Size 2.2 |
| | K Internal cushion width | 23cm (9") Size 1.1 28cm (11") Size 1.2 | 28cm (11") Size 2.1 33cm (13") Size 2.2 |
| | L Centre of thigh contours | 15cm (6") Size 1.1 17cm (6.5") Size 1.2 | 18cm (7") Size 2.1 20cm (8") Size 2.2 |
| | M Cushion side height | 14cm (5.5") | 14cm (5.5") |
| | N Thigh contour height | 9cm (3.5") | 9cm (3.5") |
| | O Abductor contour height | 5cm (2") | 5cm (2") |
| P Back cushion width | 33cm (13") | 38cm (15") | |
| Q Trunk cushion width | 26cm (10") | 30cm (12") | |
| Stroller specs | Frame seat depth capacity | 18-30cm (7-12") | 20-38cm (8-15") |
| | Frame back height capacity | 36-46cm (14-18") | 41-55cm (16-22") |
| | Backrest recline angle | 90-160° | |
| | Height of push bar | 75-110cm (29.5-43") | |
| | Overall frame width | 63cm (25") | 68cm (27") |
| | Max load of seat unit | 50kg (110lb) (body weight including other load) | |
| Base frame capacity | 60kg (132lb) | | |

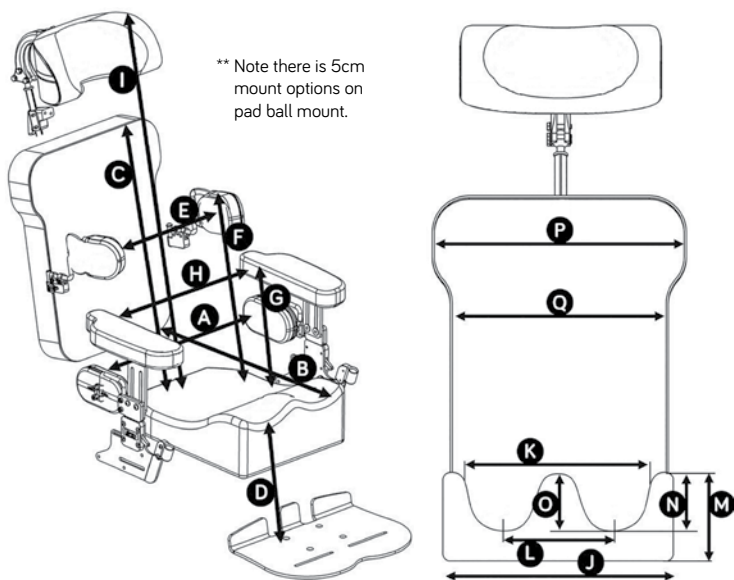

spex® | Wonderseat Adjustable seating and stroller



Cobra height-adjustable indoor base. The seat easily transfers into the Cobra for feeding and activity times. Tilt setting can still be adjusted.
Size 1: 2880-8711-000
Size 2: 2880-8721-000



Seat in forward facing direction.



Seat in rear facing direction.

Rehabilitative care improves with innovative Spex seating.



AXIAL® PELVIC SUPPORTS

Multi-adjustable pelvic supports can orientate in width and angle for optimum pelvic control. These pads are mounted to the quick-release hardware meaning transfers are easy.
Size 1: 2885-1111-000
Size 2: 2885-1112-000



SPEX BACK SUPPORT

Comfortable pressure-reducing back support with contouring cell system to permit a personal contour for bony prominences, scoliosis and other asymmetrical back postures.
Size 1: 2885-2012-0XX
Size 2: 2885-2014-0XX



SPEX SUPERHIGH CUSHION

Specially designed for a young child who has moderate to high positioning requirements. Spex Superhigh offers optimal adduction and abduction contours to effectively position the pelvis and legs. Spex positioning technology allows further adjustment for pelvic obliquity, hip flexion and other clinical requirements.
1.1: 2885-0610-0XX **1.2:** 2885-0611-0XX
2.1: 2885-0612-0XX **2.2:** 2885-0613-0XX

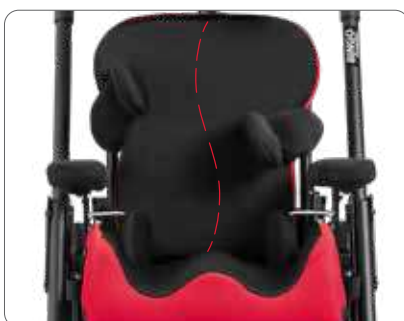

AXIAL LATERAL TRUNK SUPPORTS

Comfortable lateral supports that are width, depth and multiple angle adjustable. Patented mechanically rotational system allows the lateral pad to rotate to correctly align to the user's trunk. Swing-away hardware make it easy for carers to transfer the child in and out.

Narrow: 2885-3410-291
Broad: 2885-3431-291



FOREARM SUPPORTS

Comfortable, padded forearm supports on quick-release hardware make transfers easy for the carers.
Size 1: 2885-5621-291
Size 2: 2885-5622-291



FEET POSITIONING SANDALS

Straps can be fixed in a variety of ways to achieve the most appropriate support for each child. Independently adjustable to exactly accommodate the optimum foot position.
Sandals: 2885-6081-000
Sandal Raising Blocks: 2885-6091-000

spex[®]

Our heritage.

Since 1990, Medifab has engineered specialised seating products that provide the optimal blend of form, function and comfort.



The Spex brand is a cultivated result from over 25 years of research, trial, and listening to customer feedback. As industry innovators, we have worked with top clinicians, and tested our products to perform and satisfy. Distinguished by high standards of design and clinical evaluation, Spex delivers a superior clinical seating packed with advantages.



Benefits of Spex

Spex seating is intended for users who require postural support, and accomplishes what the seating clinician desires, with a focus on minimising the time taken to reach the solution, and ease of ongoing adaptation.

- Clinically appropriate seating choice
- Easy to use from installation to completion
- Solves clients seating needs in minimal time
- Customisable to suit different postural deviations
- Modular flexibility to accommodate changing postural needs
- Installs on virtually any wheelchair base
- Breathable for temperature control
- Standard sizes from 10" paediatrics to large adults with non-standard sizes by request
- Wheelchair transportation safety standards certified

Hardware

Spex configurable hardware is the outcome of engineering achievements with a goal to establish an easy-to-install support interface that suits virtually anybody and any wheelchair.

Crash tested and certified to RESNA WC-4, Section 20 and ISO16840-4 transport standards when used with a WC19/ISO 7179-19 compliant wheelchair base frame, you can be reassured that Spex will live up to its brand attributes of being resilient and durable.

Spex hardware can be deployed as the building blocks for other customised and moulded seating systems.

Note: Utilising the new series hardware in conjunction with previous hardware is not recommended due to testing and certification reasons.

Axial® technology

With many clients having asymmetrical body contours and requiring their posture to be supported and maintained, our patented Axial technology provides the correct surface contact and support structure with a mechanically rotational system.

Axial hardware allows the support pad to be set at any angle to meet rotated pelvis, wind-sweeping, scoliosis etc. so the pad interface is in the exact corresponding position for full surface contact benefitting by distributing weight and therefore reducing pressure, whether on a lateral pelvic/thigh support, lateral trunk support or medial thigh/knee block or other body support.

Z-bars allow unimpeded adjustability for setting support pads at the desired width and angle for maintaining clinically correct posture. In addition to the rotational pad adjustment, the Z-bars allow infinite offset capabilities and width adjustment.

Spex is the subject of patents, patents pending, design rights and copyright. Medifab places great value in these intellectual property rights and reserves its right to protect them where necessary. User instructions can be downloaded at www.Spexseating.com/resources. Spex seating may not function as intended when used at extreme temperatures; keep away from sources of moisture and extreme temperatures.

Codes for Standard Sized Cushions

Our cushion codes are meaningful!

Here's how to generate a product code to place your order.

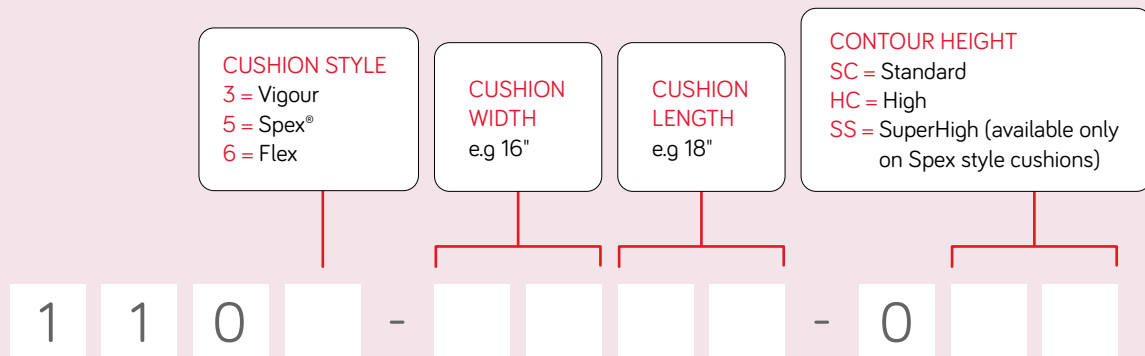

EXAMPLE

A standard Contour Spex cushion of width 18" and length 20", would have the code 1105-1820-OSC.

SPEX & VIGOUR CUSHION MEASUREMENTS GUIDE

This FRONT-VIEW of a Spex/Vigour cushion, shows the different measurements referred to on the subsequent product pages.

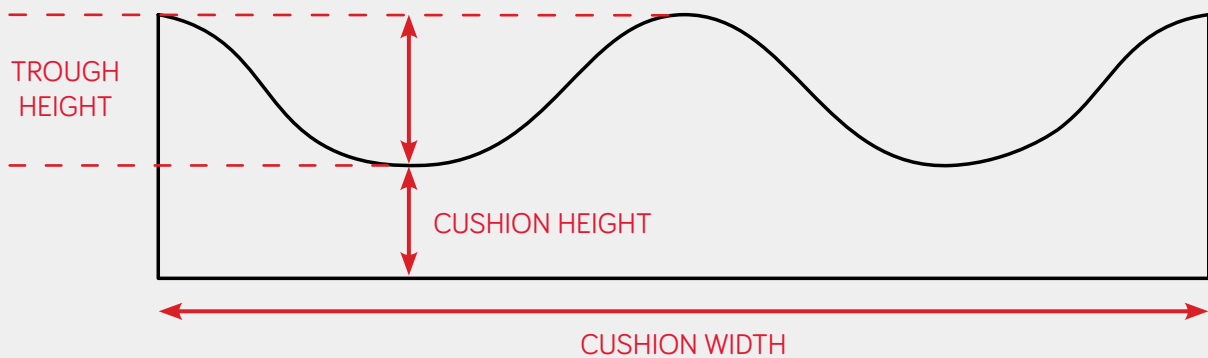

Stand out from the crowd!

Upgrade your cushion with a splash of colour, for no extra cost!

We offer 5 colour options for our Spex cushion outer covers alternative to the standard black fabric. Simply add the upgrade codes to your cushion order.



Calypso Pink
1111-0491-028



Chilli Red
1111-0491-022



Granite Grey
1111-0491-090



Mango Orange
1111-0491-030

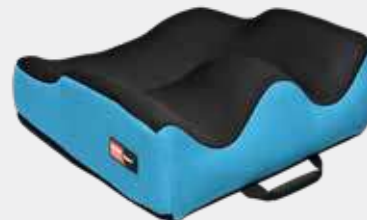

Ocean Blue
1111-0491-060

Spare cushion covers

All our cushions come standard with an inner incontinence cover and an outer cover, however if you would like a spare incontinence or outer cover, these are available.

See our scripting and ordering guide for ordering codes or get in touch with your local Spex distributor.



Vigour Cushion



CLINICAL

Designed for the user who:

- Requires pressure reduction and redistribution
- Requires pelvic stability
- Needs moderate control of posture and upper extremities
- Needs moderate control of abduction or adduction propensities

FUNCTIONAL

- Gel-foam ischial well evenly distributes pressure under the pelvis
- Special foam layers' combination, strategically combined to offer a supportive foundation for a correct seating posture
- Slight thigh elevation built-in for increased balance
- Specific contouring offers a high degree of pelvic stability
- Coccyx channel for enhanced pressure relief (for sizes 16" +)
- Dual-layer cover reduces shear forces, and breathable air-mesh on cushion sides counters moisture
- Inner incontinence cover included
- Customisable for many requirements such as leg length discrepancies

CUSHION SIZE CHART

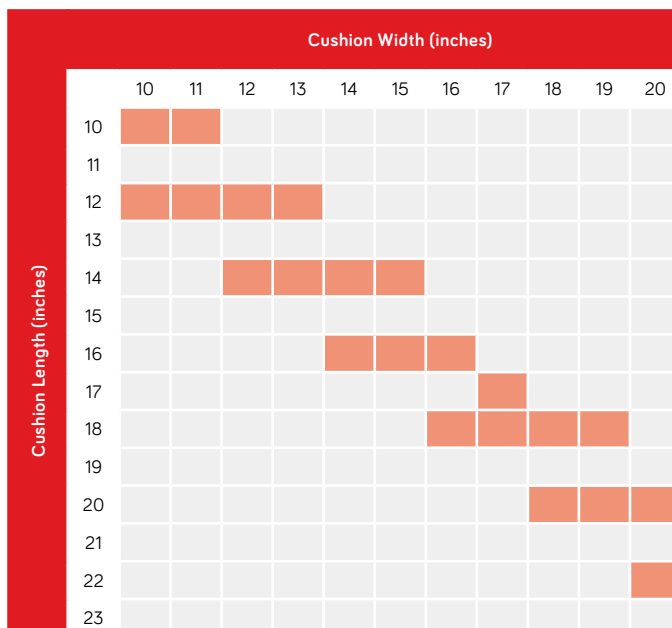

- Red squares are standard sizes.
- Non-standard or custom sizes are available on request.

CUSHION DETAILS

| Width | Height | Capacity | Trough Height (mm) | | Product Weight | |
|---------|--------|----------------|--------------------|------|----------------|--------------|
| | | | Std | High | Std | High |
| 10" | 2" | 200lbs (90kg) | | | | |
| 11"-15" | 2.5" | | 30 | 50 | (16x16) | (16x16) |
| 16"-17" | 2.75" | 350lbs (160kg) | | | 1.4kg | 1.5kg |
| 18"-20" | 3" | | | | | |

PRODUCT PERFORMANCE

| | | | | | |
|-------------------|-----|-----|---|--|--|
| Pressure Care | Red | Red | 3 | | |
| Positioning | Red | Red | 3 | | |
| Lateral Stability | Red | Red | 3 | | |
| Offloading | Red | Red | 3 | | |
| Changing Needs | 1 | | | | |

- Note: This is a guide only and ratings are dependent on correct use of product.

Spex® Standard Contour Cushion



CLINICAL

Designed for the user who has moderate to severe postural needs and pressure requirements. Excellent choice for individuals who:

- Have changing postural needs over time
- Have a symmetrical or asymmetrical sitting posture that requires correction or control
- Require pelvic support and pressure relief/distribution
- Require a high degree of pelvic stability and specific contouring
- Need moderate control of abduction or adduction propensities

FUNCTIONAL

- Created as the solution-solver for asymmetrical postures
- Strategic contouring pads offer complete customisations on-the-spot for a perfect fit for the client
- Gel-foam ischial well evenly distributes pressure under the pelvis
- Coccyx channel for enhanced pressure relief (for sizes 16" +)
- Dual-layer cover reduces shear forces, and breathable air-mesh on cushion sides counters moisture
- Inner incontinence cover included
- Customisable for many requirements such as leg length discrepancies

CUSHION SIZE CHART

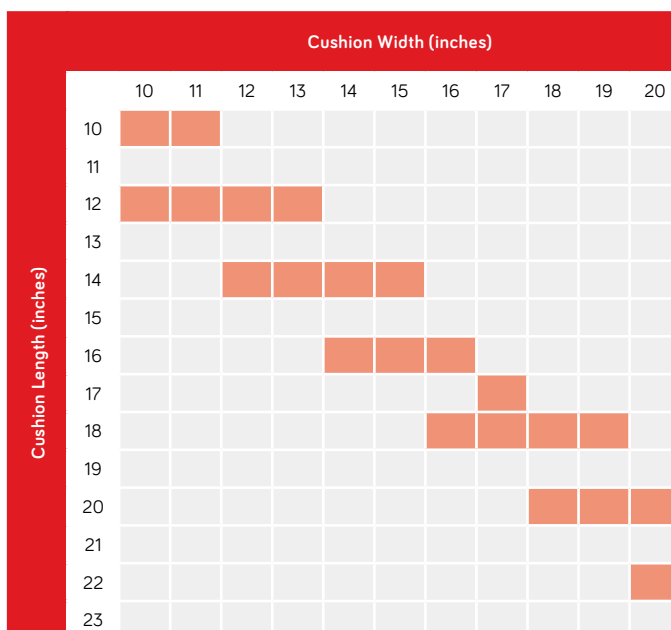

- Red squares are standard sizes.
- Non-standard or custom sizes are available on request.

CUSHION DETAILS

| Width | Height | Capacity | Trough Height | Product Weight |
|---------|--------|----------------|---------------|-------------------------|
| 10" | 2" | 200lbs (90kg) | 30mm | (16x16) 1.5kg |
| 11"-15" | 2.5" | | | |
| 16"-17" | 2.75" | 350lbs (160kg) | | |
| 18"-20" | 3" | | | |

PRODUCT PERFORMANCE

| | | | | |
|-------------------|-----|-----|-----|---|
| Pressure Care | Red | Red | Red | 4 |
| Positioning | Red | Red | Red | 4 |
| Lateral Stability | Red | Red | 3 | |
| Offloading | Red | Red | Red | 4 |
| Changing Needs | Red | Red | Red | 4 |

- Note: This is a guide only and ratings are dependent on correct use of product.

Spex® High Contour Cushion

The Spex High Contour Cushion offers enhanced thigh and abductor support. Key solution to positioning and levelling the pelvis correctly and effectively. Accomplish on-the-spot modifications with the cushion's strategic positioning base.

CLINICAL

Designed for the user who has moderate to severe postural needs and pressure requirements. Excellent choice for individuals who:

- Need high control of abduction or adduction propensities
- Have changing postural needs over time
- Have a symmetrical or asymmetrical sitting posture that requires correction or control
- Require pelvic comfort and pressure relief/distribution
- Require a high degree of pelvic stability and specific contouring

FUNCTIONAL

- Positioning base promotes anterior pelvic tilt and active reach to engage in activities
- Created as the solution-solver for asymmetrical postures
- Strategic contouring pads offer complete customisations on-the-spot for a perfect fit for the client
- Gel-foam ischial well evenly distributes pressure under the pelvis
- Coccyx channel for enhanced pressure relief (for sizes 16" +)
- Dual-layer cover reduces shear forces, and breathable air-mesh on cushion sides counters moisture
- Inner incontinence cover included
- Customisable for many requirements such as leg length discrepancies



Bespoke modifications can be scripted according to needs of the user.



SPEX STRATEGIC POSITIONING BASE



Configure to suit many different postures of persons with disabilities or sitting issues. By adjusting the strategic positioning base, the cushion surface is contoured to improve overall posture, pelvic alignment, sitting ability, comfort and pressure reduction.



PROMOTES ANTERIOR PELVIC TILT AND ACTIVE REACH TO ENGAGE IN ACTIVITIES

Cushion can be wedged to slope to front with cells added at rear and removed at front.

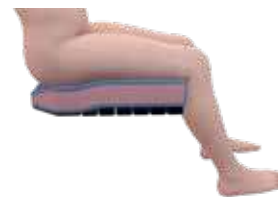

MANAGEMENT & POSITIONING

Build cells up under thighs for enhanced pre-ischial support and control.



PELVIC ROTATION

To help control pelvis from rotating, create a build-up under the affected leg (in front of the ischial).



Unique dual-layer **SHEAR REDUCTION** fabric surface

Accentuated thigh/adductor and abductor **CONTROL AND SUPPORT**

CUSTOMISE for all sitting postures

Maintain **PELVIC STABILITY** with adjustable positioning base

CUSHION SIZE CHART

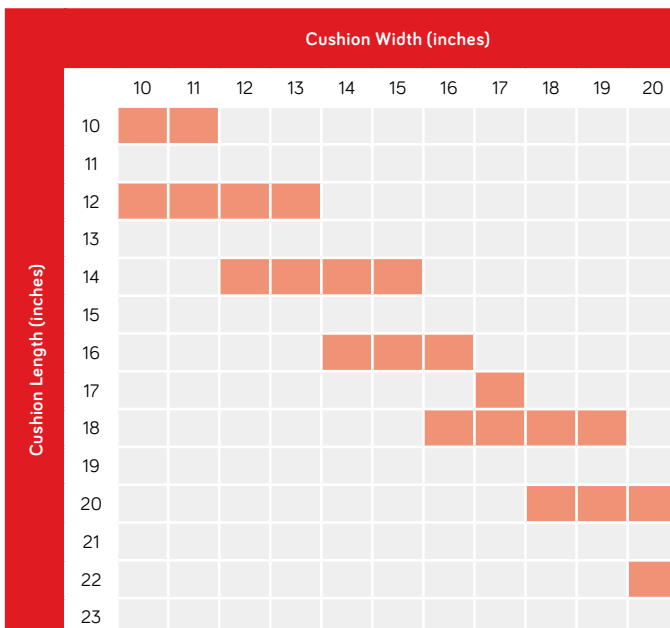

- Red squares are standard sizes.
- Non-standard or custom sizes are available on request.

CUSHION DETAILS

| Width | Height | Capacity | Trough Height | Product Weight |
|---------|--------|----------------|---------------|-------------------------|
| 10" | 2" | 200lbs (90kg) | 50mm | (16x16) 1.6kg |
| 11"-15" | 2.5" | | | |
| 16"-17" | 2.75" | 350lbs (160kg) | | |
| 18"-20" | 3" | | | |

PRODUCT PERFORMANCE

| | | | | | |
|-------------------|-----|-----|-----|---|--|
| Pressure Care | Red | Red | Red | 4 | |
| Positioning | Red | Red | Red | 4 | |
| Lateral Stability | Red | Red | Red | 4 | |
| Offloading | Red | Red | Red | 4 | |
| Changing Needs | Red | Red | Red | 4 | |

- Note: This is a guide only and ratings are dependent on correct use of product.

Spex® SuperHigh Contour Cushion

Using the proven Spex strategic positioning base technology, the SuperHigh contour cushion creates an optimum pelvic foundation for the user that requires extra pelvic and hip support.

The medial thigh support combined with lateral thigh supports maximizes the user stability, providing greater balance and support on upper body. The SuperHigh contour cushion's body-hugging nature delivers comfort and daily sitting relief; while the 3D breathable mesh fabric helps in reducing moisture and temperature.

CLINICAL

Designed for the user who has moderate to severe positioning requirements. Excellent choice for individuals who:

- Require extra pelvic, hip stability, and specific contouring
- Have muscle tone patterns that require sufficient thigh lateral control. Thigh support is higher for alignment - refer measurement table
- If extremity support can't be maintained through the use of external thigh laterals and/or if installing thigh laterals can't be used, the SuperHigh contour cushion will provide that needed support and stabilisation
- Have a symmetrical or asymmetrical sitting posture that requires correction or control/accommodation

FUNCTIONAL

- No maintenance required. A reliable, peace-of-mind solution!
- Strategic contouring pads offer complete customisations on-the-spot for a perfect fit for the client
- Removable lateral rigidizers which add extra thigh support/alignment
- Gel-foam ischial well evenly distributes pressure under the pelvis
- Coccyx channel for enhanced pressure relief (for sizes 16"+)
- Dual-layer cover reduces shear forces, and breathable air-mesh on cushion sides counters moisture
- Inner incontinence cover included
- Customisable for many requirements such as leg length discrepancies
- Not compatible with Thigh Supports or Medial Thigh Supports

Bespoke modifications can be scripted according to needs of the user.



Full length contouring customisation without 50mm rear step (shown in red on right) can be made with no additional cost.

1111-0304-000



SPEX STRATEGIC POSITIONING BASE



Configure to suit many different postures of persons with disabilities or sitting issues. By adjusting the strategic positioning base, the cushion surface is contoured to improve overall posture, pelvic alignment, sitting ability, comfort and pressure reduction.



PROMOTES ANTERIOR PELVIC TILT AND ACTIVE REACH TO ENGAGE IN ACTIVITIES

Cushion can be wedged to slope to front with cells added at rear and removed at front.



MANAGEMENT & POSITIONING

Build cells up under thighs for enhanced pre-ischial support and control.



PELVIC ROTATION

To help control pelvis from rotating, create a build-up under the affected leg (in front of the ischial).



Lower **REAR CONTOURING** allows for improved hip belt positioning

Deep **PELVIC IMMERSION** for anti-thrust needs

Super high medial and lateral contouring for **STABILITY AND CONTROL**

Cross-linked foam profiles for **DURABILITY**

Maintain **PELVIC STABILITY** with adjustable positioning base

CUSHION SIZE CHART

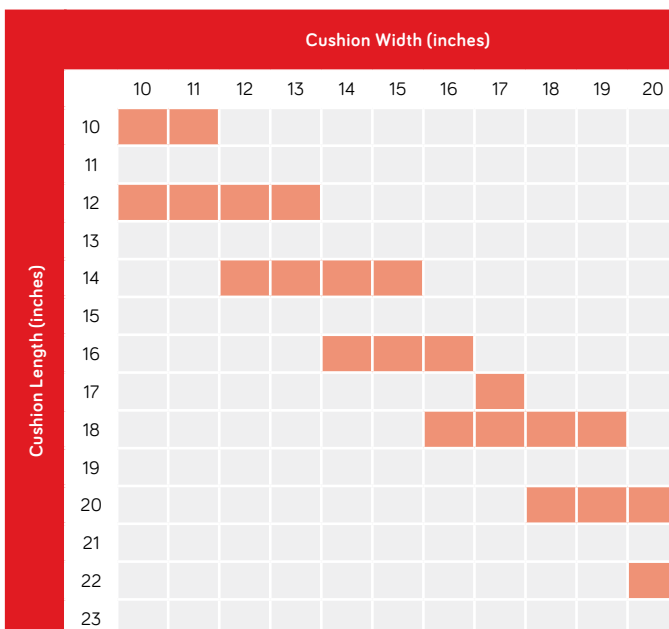

- Red squares are standard sizes.
- Non-standard or custom sizes are available on request.
- SuperHigh cushion not compatible with Thigh Supports or Medial Thigh Supports

CUSHION DETAILS

| Width | Height | Capacity | Trough Height | Product Weight |
|---------|--------|----------------|---------------|-------------------------|
| 10" | 2" | 200lbs (90kg) | 80mm | (16x16) 2.0kg |
| 11"-13" | 2.5" | | | |
| 14"-15" | 2.5" | 350lbs (160kg) | 100mm | |
| 16"-17" | 2.75" | | | |
| 18"-20" | 3" | | | |

PRODUCT PERFORMANCE

Spex SuperHigh

| | | | | | |
|-------------------|--|--|---|---|---|
| Pressure Care | | | | 4 | |
| Positioning | | | | 4 | |
| Lateral Stability | | | | | 5 |
| Offloading | | | | 4 | |
| Changing Needs | | | 3 | | |

Spex SuperHigh (full length contouring)

| | | | | | |
|-------------------|--|--|---|---|---|
| Pressure Care | | | 3 | | |
| Positioning | | | | 4 | |
| Lateral Stability | | | | | 5 |
| Offloading | | | 3 | | |
| Changing Needs | | | 3 | | |

- Note: This is a guide only and ratings are dependent on correct use of product.

NEW Spex® Flex Cushion

Creating possibilities for complex sitting postures!

Flex cushion implements a truly adaptable and easy approach for even the hardest-to-solve cushion requirements for users with complex postures.

As its name describes, Flex has been designed to fulfil the postural requirements of wheelchair users who present with limited hip flexion. Up-to-date research shows that a considerable number of clients with cerebral palsy at GMFCS level V, present with asymmetric limited hip flexion. This condition must be ruled out or compensated as it has been linked to the development of other conditions like pelvic obliquity, trunk asymmetry, scoliosis, and windswept hip distortion (Ágústsson, A. et al, 2017).

Considering a lack of products available that can support clients with symmetric or asymmetric limited hip flexion, and considering the negative impact that this can have on people's posture and function, we have developed this superior, comfortable, pressure relieving, stable and highly configurable cushion able to address even the most challenging postural requirements.

Every Flex comes with an easily configurable strategic positioning base. The innovative and clinical benefits of the pads and wedges allows the prescribing clinician to achieve a result on-the-spot whilst having the peace of mind that its able to change for future unseen posture changes.

Flex has a unique cover design which can change its shape. This ensures that once all the adaptations are done to the inner foam unit, the incontinence and outer covers are manipulated for a comfortable fit.



CLINICAL APPLICATIONS

Excellent choice for individuals who:

- Have symmetrical or asymmetrical limited hip flexion
- Have internal hip rotation with tight hamstrings on one side
- Require pelvic and thighs pressure distribution due to asymmetric sitting posture
- Have changing postural needs over time
- Require a high degree of pelvic stability and specific contouring

FUNCTIONAL

- Positioning base primarily accommodates lack of hip flexion up to 20° but due to its innovative positioning base it can support ruling out other associated deformities as pelvic obliquity, windsweeping, hip abduction, hip internal rotation with tight hamstrings and even lack of hip extension.
- Strategic positioning base, pads and wedges offer complete customisations on-the-spot for a perfect fit for the user
- Bevelled front edge allow for knee contractures
- The exceptional combination of top foam overlays guarantees pressure distribution throughout the complete surface
- Outer breathable cover and inner incontinence cover included
- Customisable for individual requirements such as higher thigh supports, leg length discrepancies, among others.



FLEX CUSHION AND ITS INNOVATIVE POSITIONING BASE



Strategic positioning base offers on-the-spot customisations to accommodate even the most complex postural needs.



Asymmetric limited hip flexion is achieved by removing one or more front wedges from that side, depending on the angle required.



Lack of hip flexion on one side with lack of hip extension on the other is now possible to be compensated by changing the wedges from one side to the other. If pelvic obliquity is present, positioning pads provided with the cushion must be adjusted as well.



Symmetric limited hip flexion is achieved by removing one or more front wedges from both sides, depending on the angle required.



If hip abduction needs to be addressed, the frontal segments of the cushions can be pulled apart and locked in place with an additional wedge (provided).



If a moderate windsweeping needs to be accommodated, the frontal segments of the cushion can be slightly angled.

CUSHION SIZE CHART

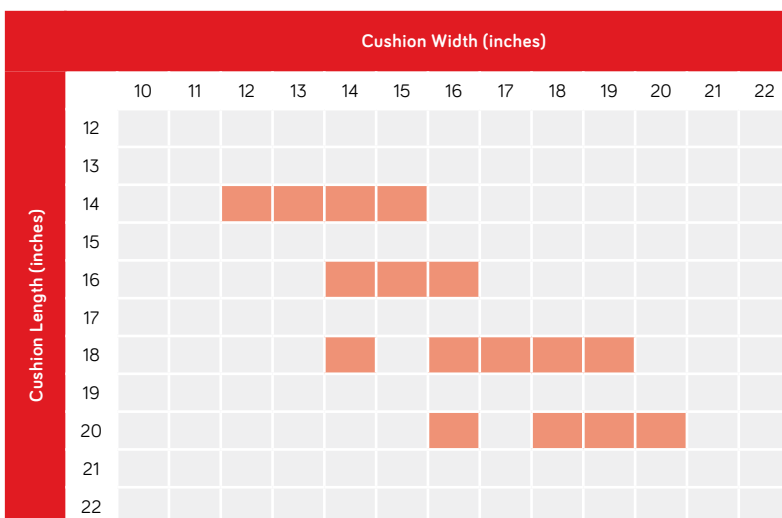

- Red squares are standard sizes.
- Non-standard or custom sizes are available on request.
- Standard Contour Flex Cushion is default option (as pictured). SuperHigh Contour available upon request (non-trial option).

CUSHION DETAILS

| Length | Height | Capacity | Trough Height (mm) | | Product Weight |
|---------|--------|----------------------------------|--------------------|------|----------------|
| | | | Std | High | |
| 14"-15" | 4.7" | Width < 16" 200lbs (90kg) | 30 | 50 | (16x16) |
| 16" | | | | | |
| 17"-20" | 5.1" | Width > 16" 350lbs (160kg) | | | 1.5kg |

PRODUCT PERFORMANCE

| | | | | |
|-------------------|--|--|---|---|
| Pressure Care | | | | 4 |
| Positioning | | | | 5 |
| Lateral Stability | | | 4 | |
| Offloading | | | | 5 |
| Changing Needs | | | | 5 |

- Note: This is a guide only and ratings are dependent on correct use of product.

Codes for Standard Sized Back Supports

Our back support codes are meaningful!

Here's how to generate a product code to place your order.

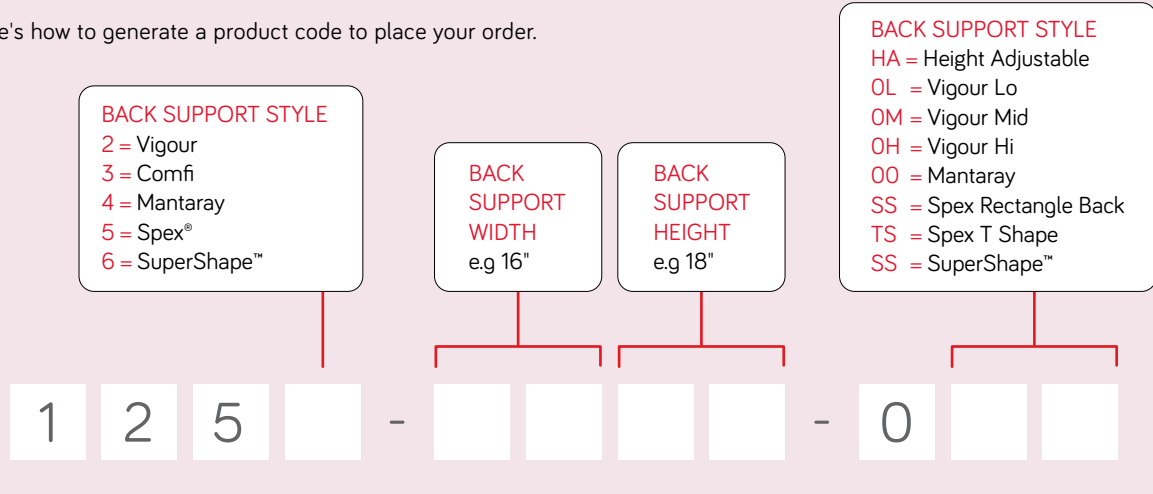

EXAMPLE

A Spex T Shape Back Support of width 18" and height 20", would have the code 1255-1820-OTS.

Stand out from the crowd!

Upgrade your back support with a splash of colour, for no extra cost!

We offer 5 colour options for our Spex back support outer covers alternative to the standard black fabric. Simply add the upgrade codes to your back support order.



Calypso Pink
1209-2491-028



Chilli Red
1209-2491-022



Granite Grey
1209-2491-090



Mango Orange
1209-2491-030



Ocean Blue
1209-2491-060

SPARE OUTER COVERS for any Spex back support are available for purchase. Refer to the Spex ordering and scripting guide for details, or get in touch with your local Spex distributor.

Spex® Back Support Hardware Options

QUAD MOUNT (DEFAULT)

Quad Mount hardware is the default hardware option for Spex Back Supports and uses four independent points of attachment to the back support canes of the wheelchair for ultimate strength and lateral positioning. This hardware type offers 40mm of seat depth adjustment, and is available in three different variants:

QUAD MOUNT (DEFAULT)

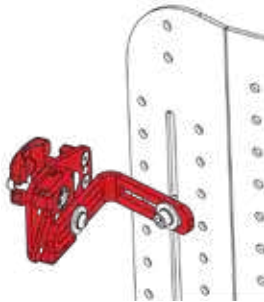

- Has a unique locking system that allows the back support to be removed easily
- Provides 10° of back support angle
- Weighs 0.9kg

FIXED MOUNT

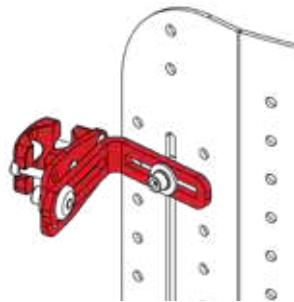

- Back support is non-removable without the use of tools but is lighter (and a more cost-effective option)
- Limits adjustability and back support angle
- Weighs 0.6kg

HEAVY-DUTY QUICK-RELEASE

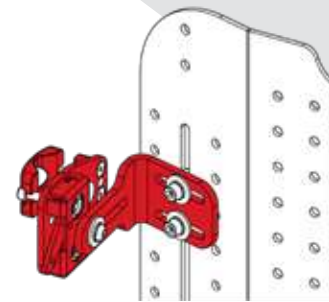

- Supports heavier users with stronger L-brackets
- Shares the benefits of quick release hardware
- Weighs 1.1kg

DUAL MOUNT (OPTION)

Dual Mount hardware has two points of attachment to the back support canes of a wheelchair and offers simpler set up, increased adjustability, angle, and growth. It utilises the same quick-release hook and latch operation to secure the back support. Please note, this hardware option cannot be used on most wheelchairs that have a horizontal back cross brace.

Dual Mount hardware allows for:

- 40mm of seat depth adjustment
- 30° of back support angle
- Weighs 1.1kg

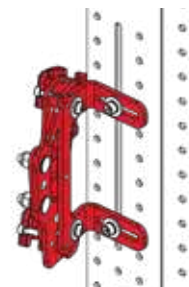

SINGLE MOUNT (OPTION)

Single Mount hardware is a lightweight option for lower height back supports and has two points of attachment to the back support canes of a wheelchair. Like Dual Mount, this hardware option also offers simpler set up, increased adjustability, angle, and growth, and allows for:

- 45mm of seat depth adjustment
- 30° of back support angle
- Weighs 0.9kg

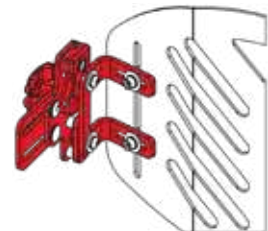

BACK SUPPORT HARDWARE ACCESSORIES/ATTACHMENTS

QUAD/SINGLE MOUNT WIDTH EXTENSIONS

Allows mounting of back supports up to 3" wider than the chair width, depending on the size of the back support. Cannot be used on Quad Mount HD.

- Weighs 0.1kg (set of 4)
- 1259-2490-100

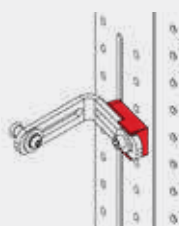

QUAD MOUNT DEPTH EXTENSIONS

Increase back angle by 10° (set of 2 for upper mounts)

- Weighs 0.1kg
- 1259-2450-100

Increase seat depth by 4" (set of 4 for all mounts)

- Weighs 0.2kg
- 1259-2452-100



Vigour Back Support

Lightweight yet tough to meet the daily lifestyle demands of active wheelchair users. Back support angle and seat depth offers exceptional adjustability and can be facilitated with the user in the wheelchair. Ventilated spacer-fabric and shell system increases air-flow through the back offering daily comfort.

VIGOUR LO

New invertible shell design means the Vigour Lo can be used either way up on the wheelchair. Sacral and lumbar height support allowing unrestricted upper body range of movement.

Designed for the individual who requires:

- A solid back support with the ability to self-propel
- Minimal postural support
- Improved spinal and pelvic positioning whilst maintaining propelling efficiency
- For clients that have mild torso asymmetries



VIGOUR MID

Lightweight and designed for efficient propelling, with scapular subtractions for unimpeded arm function.

Designed for the individual who requires:

- A solid back support with the ability to self-propel
- Minimal to moderate postural support
- Improved spinal and pelvic positioning whilst maintaining propelling efficiency
- In combination with lateral supports offers exceptional trunk and thoracic stability
- For clients that have mild torso asymmetries



VIGOUR HI

Solid full height back support available in three heights for maximum trunk and shoulder support.

Designed for the individual who requires:

- A solid back support
- Minimal to moderate postural support
- Improved spinal and pelvic positioning whilst maintaining propelling efficiency
- In combination with lateral supports offers exceptional trunk and thoracic stability



MICRO-CUBE FOAM UPGRADE

Air-flow breathability for maximum control of temperature and moisture.

Micro-cube cells provide zoned weight distribution enhancing comfort.

1209-2351-300





Dual-layer cover reduces **SHEAR FORCES** with air-mesh side panels to counter moisture and temperature

Add laterals as required from our **LARGE MODULAR RANGE**

Can be upgraded with **DIFFERENT FOAM PADDING OPTIONS** for excellent results

SLOTS & HOLE POSITIONS on shell allow easy installation of head supports, lateral supports and harnesses

SIZE CHART



- Red squares are standard sizes.
- Non-standard or custom sizes are available on request.

PRODUCT DETAILS

| Width | Height | Capacity | Product Weight |
|---------|--------|----------------|----------------------------------|
| 10" | 2" | 200lbs (90kg) | Lo Back (16x10) 0.7kg |
| 11"-15" | 2.5" | | Mid Back (16x16) 1.0kg |
| 16"-17" | 2.75" | 300lbs (136kg) | Hi Back (16x16) 1.3kg |
| 18"-20" | 3" | | |

- Note: This is the weight of the back support only and does not include the hardware. For hardware weight, refer to page 29.

PRODUCT PERFORMANCE

| | | | | | |
|----------------------|-----|-----|-----|---|--|
| Postural Control | Red | Red | Red | 4 | |
| Lateral Stability | Red | Red | 3 | | |
| Postural Asymmetries | Red | Red | 3 | | |
| Changing Needs | Red | Red | 3 | | |
| Pressure Care | Red | Red | 3 | | |

- Note: This is a guide only and ratings are dependent on correct use of product.

- Vigour Lo Back Support
- Vigour Mid Back Support
- Vigour Hi Back Support

NEW Height-Adjustable Back Support

The newest back support shell style in the Spex range, retaining all the lightweight yet sturdy features of the Vigour and Spex Back Supports and incorporating inbuilt growth adjustment due to the unique shell style.

THE BACK SUPPORT THAT STRETCHES FOR FUTURE GROWTH!

An innovative back support shell style retains all the lightweight yet sturdy features of the Vigour and Spex Back Supports yet incorporates inbuilt growth adjustment due to the unique shell style.

This growth system has an upper sliding interface and allows up to 4" / 10cm of additional growth adjustment meaning that from the initial wheelchair set-up the prescriber can rest assured that the back support can grow in height as the user grows. This is particularly effective for paediatrics

The foam and upholstery unit is matched for the longest growth setting meaning that you don't have to purchase different sizes of padding as the user grows.

The height-adjustable shell is available with the following padding options:

- Vigour foam: for users with symmetrical postures.
- Micro-cube foam: for users that require heat reduction and comfort
- Spex contourable cube padding: for users with asymmetries and require pressure reduction

CLINICAL APPLICATIONS

Designed for the individual who requires:

- Future growth ability
- A specific height of back support (without the concern of purchasing a custom item)
- Multiple user applications or assessments
- Users pending surgery with ongoing changes to their wheelchair seating

FUNCTIONAL

- When a wheelchair user grows, this is typically predominantly in height more than in width
- Foam padding follows adjustments made
- Available in sizes to fit 10" to 18" wheelchairs
- Available with Vigour, Micro-cube and Spex foam padding
- Height adjustment can be done on the spot without additional parts required

MICRO-CUBE FOAM UPGRADE

Air-flow breathability for maximum control of temperature and moisture. Micro-cube cells provide zoned weight distribution enhancing comfort.



1209-2351-300

HARDWARE ADJUSTMENTS



Height adjustment feature



Padding tucks under back support when at lower height range

Padding extends with back support when height is extended

QUAD MOUNT WIDTH-ADJUST BRACKETS



For narrow width wheelchairs



Quad mount width-adjust brackets (can also be used with single mount hardware). Enables back support to be mounted on a greater variety width of wheelchairs. Allows 60mm narrower width adjustment overall.

1259-2490-100

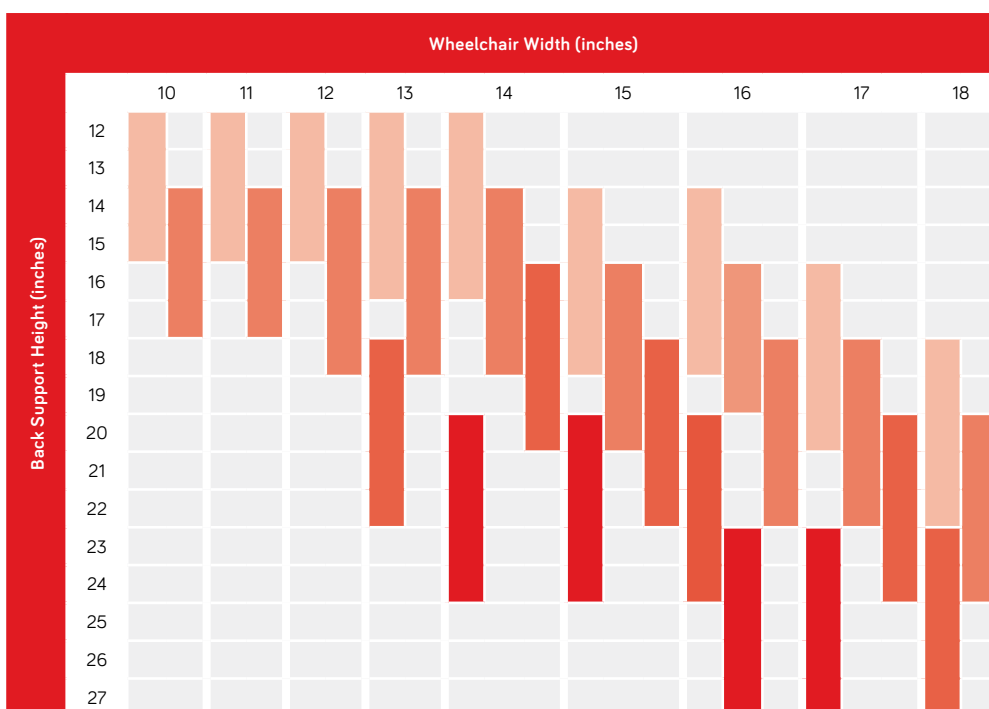

PRODUCT CODES

To order the correct product using the code guide on page 28, Back Support Width is the size shown across the table, and Back Support Height, shown on the left, is the first size shown in the shaded area.

EXAMPLE

To order a 14" wide by 18" high support, you can order either 1414 or 1416, depending on the adjustability required.

Mantaray Back Support

Mantaray offers a solid shell with unique adjustable laterals (or wing tips!). That can be width, height and angle adjusted to give excellent lateral stability. An upholstery wrap offers comfort and secure spine and trunk support.

CLINICAL

Designed for the individual who requires:

- A solid back support to support minimal deformities or stability needs
- Minimal to moderate postural support
- Improved trunk/pelvic positioning whilst maintaining propelling efficiency
- Has mild-moderate torso asymmetries
- Greater functionality as there is minimal hardware between the client and the lateral supports

FUNCTIONAL

- Fully adjustable and repositionable lateral 'wings' means that the therapist/clinician can ensure the right support in the right place for the user
- Slick and non-obtrusive yet provides the right amount of spine and lateral stability for many different postural needs
- Lightweight solid aluminium back support with quick-release hardware
- Wrap upholstery section gives conforming comfort
- Offers exceptional trunk stability
- Minimal contouring, and includes positioning kit for further postural enhancements
- Add head supports and other positioning supports if more support is required

CONFORMING COMFORT



NEW COVER DESIGN





Dual-layer cover reduces **SHEAR FORCES** with air-mesh side panels to counter moisture and temperature

Solid back support with integrated **ADJUSTABLE LATERAL SUPPORTS**

Strong **VENTILATED SHELL** increases air flow through the back support offering daily comfort

SLOTS & HOLE POSITIONS on shell allow easy installation of head supports, lateral supports and harnesses

SIZE CHART

| | | Wheelchair Width (inches) | | | | | | | | |
|----------------------------|----|---------------------------|----|----|----|----|----|----|----|----|
| | | 12 | 13 | 14 | 15 | 16 | 17 | 18 | 19 | 20 |
| Wheelchair Height (inches) | 14 | | | | | | | | | |
| | 15 | | | | | | | | | |
| | 16 | | | | | | | | | |
| | 17 | | | | | | | | | |
| | 18 | | | | | | | | | |
| | 19 | | | | | | | | | |
| | 20 | | | | | | | | | |

- Red squares are standard sizes.
- Non-standard or custom sizes are available on request.

PRODUCT DETAILS

| Width | Capacity | Product Weight |
|---------|----------------|----------------|
| 10"-15" | 200lbs (90kg) | (16x16) |
| 16"-20" | 300lbs (136kg) | 2.2kg |

- Note: This is the weight of the back support only and does not include the hardware. For hardware weight, refer to page 29.

PRODUCT PERFORMANCE

| | | | | | |
|----------------------|--|--|---|---|---|
| Postural Control | | | | | 5 |
| Lateral Stability | | | | | 5 |
| Postural Asymmetries | | | | 4 | |
| Changing Needs | | | 3 | | |
| Pressure Care | | | 3 | | |

- Note: This is a guide only and ratings are dependent on correct use of product

MANTARAY WING ADJUSTABILITY

| W/C Width | Size | Depth Adjustment | Height Adjustment |
|-----------|------|------------------|-------------------|
| 10"-12" | 0 | 57 mm | 30 mm |
| 13"-15" | 1 | 50 mm | 30 mm |
| 16" + | 2 | 78 mm | 40 mm |

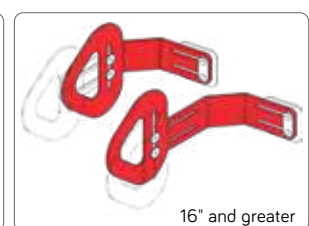

Comfi Back Support

The Comfi back support foam system was developed to provide a simplistic approach to basic contouring needs while coupling this with Spex Air-Flow technology. Skin breakdown is most often caused by three combined extrinsic factors: Pressure, shear and moisture.

CLINICAL

- Designed for the individual who requires a solid back support to assist with mild to moderate postural needs
- Ideal to assist clients who may need pressure relief in identified areas
- The cut grid shape and configuration creates a mild suspension effect which provides comfort and increases sitting tolerance
- Suitable for geriatric users who need comfort, minor shaping and pressure-relieving back surface

FUNCTIONAL

- Comfortable pressure reducing foam surface layer to absorb bony prominences.
- Cubes allow tear-off function to remove pressure areas
- Dual-layer cover reduces shear forces
- Breathable air-mesh on back support sides counters moisture and temperature
- Swap out the upholstery unit at any future point to full Spex contouring system if required, utilising the same shell and mounting hardware.

TEAR OFF CUBES

Ability to accommodate bony prominences or to relieve tender spots or lesions. Moulds without resistance to both concave and convex flexion.



INSTANT IMMERSION

Auto-conforming of the foam support unit through the combination of thermosensitive foam and cube technology.



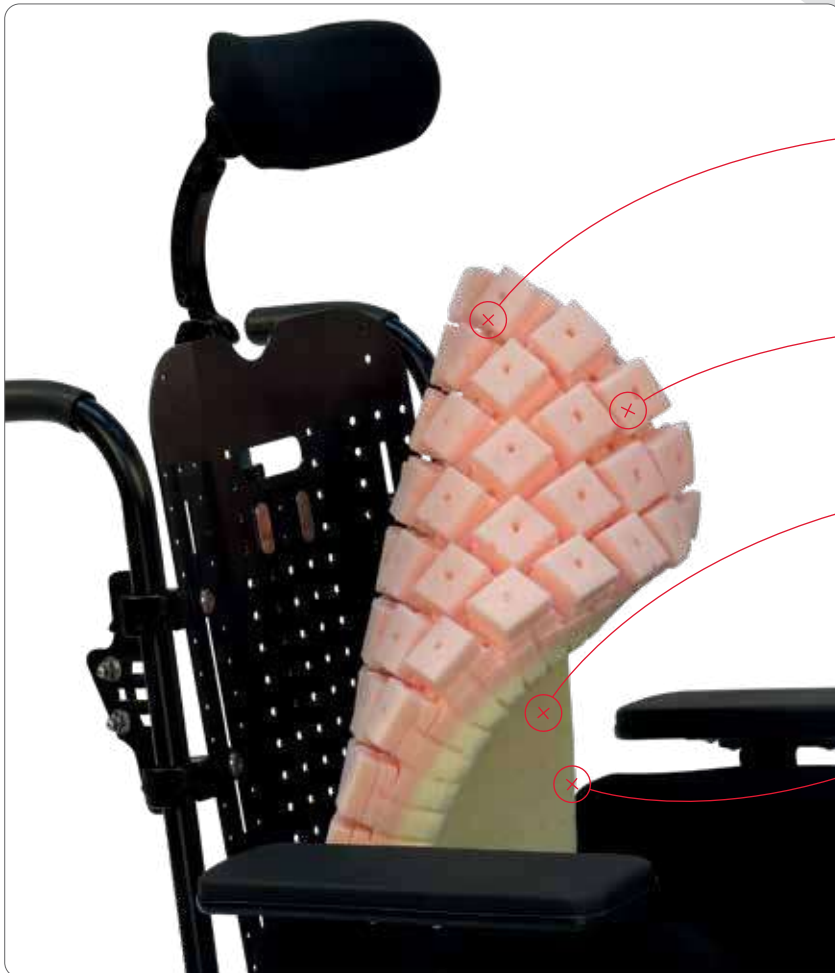

Tear-off padding to assure **PRESSURE RELIEF** in identified areas

SMOOTH CONTOURING surface

BREATHABLE CUBES increase air flow through the back support offering daily comfort

Soft memory foam overlay to provide **COMFORT AND PRESSURE REDUCTION**

SIZE CHART

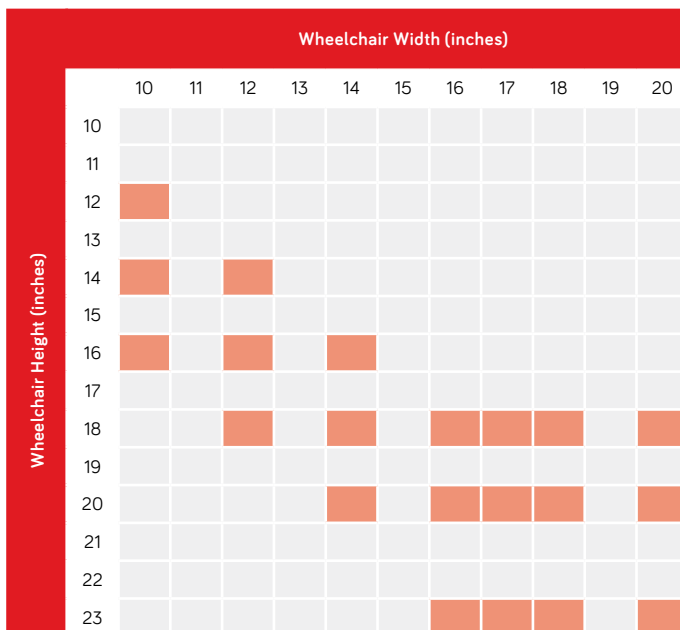

- Red squares are standard sizes.
- Non-standard or custom sizes are available on request.

PRODUCTS DETAILS

| Width | Capacity | Product Weight |
|---------|----------------|----------------|
| 10"-15" | 200lbs (90kg) | (16x16) |
| 16"-20" | 350lbs (160kg) | 0.6kg |

- Note: This is the weight of the back support only and does not include the hardware. For hardware weight, refer to page 29.

PRODUCT PERFORMANCE

| | | | | | |
|----------------------|--|--|---|---|--|
| Postural Control | | | 3 | | |
| Lateral Stability | | | | 4 | |
| Postural Asymmetries | | | | 4 | |
| Changing Needs | | | | 4 | |
| Pressure Care | | | | 4 | |

- Note: This is a guide only and ratings are dependent on correct use of product.

Spex® Back Support

Easily solve upper torso needs for most wheelchair users with the Spex exceptional upholstery section. Incorporates the Spex cube contouring cell system to allow on-the-spot customisations for torso comfort and asymmetry needs.

CLINICAL

Designed for the individual who:

- Requires a comfortable back support to reduce torso pain
- Requires spinal alignment and support
- Has skin breakdown/pressure care needs.
- Has bony or protruding skeletal prominences.
- Have changing postural needs
- Pertains a maladaptive or asymmetric posture

FUNCTIONAL

- Comfortable pressure reducing foam surface layer to absorb bony prominences
- Cube contouring cell system provides configurations for a perfect fit and shape for the client
- Customisation to contouring are performed on-the-spot
- Created as the solution-solver for asymmetrical back postures
- Modular componentry means you can 'mix and match' with different lateral pad options and positioning supports
- Offers exceptional back/shoulder contact
- Sustainable choice for issuing to other users
- Dual-layer cover reduces shear forces, and breathable air-mesh on back support sides counters moisture and temperature

RECTANGLE SHAPE

Fits between wheelchair canes



T SHAPE

Sits in front of wheelchair canes





Dual-layer cover reduces **SHEAR FORCES** with air-mesh side panels to counter moisture and temperature

Add laterals as required from our **LARGE MODULAR RANGE**

Strong **VENTILATED SHELL** increases air flow through the back support offering daily comfort

SLOTS & HOLE POSITIONS on shell allow easy installation of head supports, lateral supports and harnesses

SIZE CHART

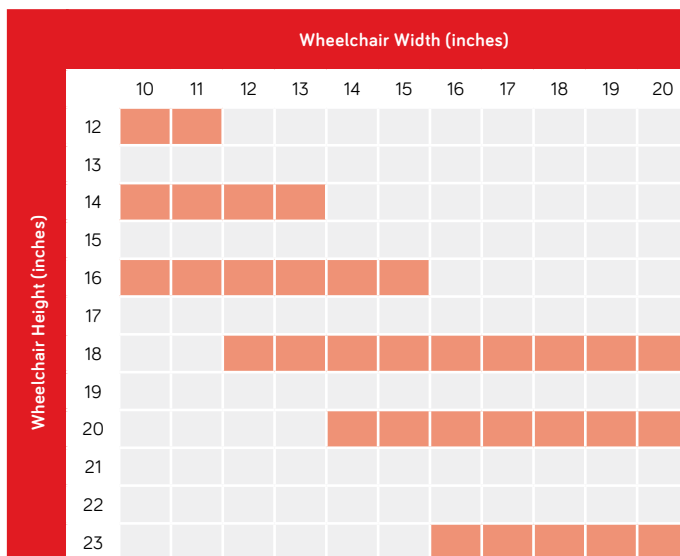

- Red squares are standard sizes.
- Non-standard or custom sizes are available on request.

PRODUCT DETAILS

| Width | Capacity | Product Weight |
|---------|----------------|----------------|
| 10"-15" | 200lbs (90kg) | (16x16) |
| 16"-20" | 300lbs (136kg) | 1.7kg |

- Note: This is the weight of the back support only and does not include the hardware. For hardware weight, refer to page 29.

PRODUCT PERFORMANCE

| | | | | | | |
|----------------------|-----|-----|-----|-----|-----|---|
| Postural Control | Red | Red | Red | Red | Red | 5 |
| Lateral Stability | Red | Red | Red | Red | Red | 5 |
| Postural Asymmetries | Red | Red | Red | Red | Red | 5 |
| Changing Needs | Red | Red | Red | Red | Red | 5 |
| Pressure Care | Red | Red | Red | Red | Red | 5 |

- Note: This is a guide only and ratings are dependent on correct use of product

Contouring the Spex® Back Support Surface

A special feature of the Spex back support is the adjustable contouring-cell cube system which incorporates into the upholstery unit of the backrest. Easy configurations are performed for asymmetrical trunk postures without the need for complicated custom/bespoke seating.

The cover un-zips from the top of the back support and remains fixed to the shell whilst you remove the inner upholstery unit. Changes to the contouring are made on-the-spot for instant results.

Further postural enhancements to the degree and depth of contouring are achieved with the positioning kit of support wedges (included with every Spex back support).



Special cover design allows the contouring cube system to be removed through the top of the back support.

FOR MILD BONY PROMINENCES

Without even adjusting the cube system, the Spex back support has slight contouring and integrates a comfortable pressure reducing foam surface layer to absorb mild bony prominences and asymmetries for uniform torso contact.



Showing front pressure-reducing surface

FOR IMMERSION

For individuals that require immersion into the backrest, simply adjust the cube contouring cell system to configure for a perfect fit and shape for the client's back.



Showing contouring cells without the front foam surface

FOR ASYMMETRY

For asymmetrical or maladaptive postures, the contour can be arranged to provide the matching shape required to support the client's torso profile.



Blank areas show where contouring pads can be fully removed, yet the foam surface still offers padded support



Instant changes can be implemented to configure the back support surface.



- + Add layers to build up areas where pronounced support is required.
- Remove layers where more immersion is required.



Customisations can be reconfigured at any time when postural needs change. Contouring doesn't move or slip out of adjustment.

Back Support Contouring Charts

Record the amount of contouring cubes used. Fill out this form and enter the number of cubes used in each pocket and save for future reference.

Use all charts below if recording contouring cubes used for the **Spex SuperShape Back Support**.

Use only the left hand chart if recording contouring cubes used for the **Spex Back Support**.

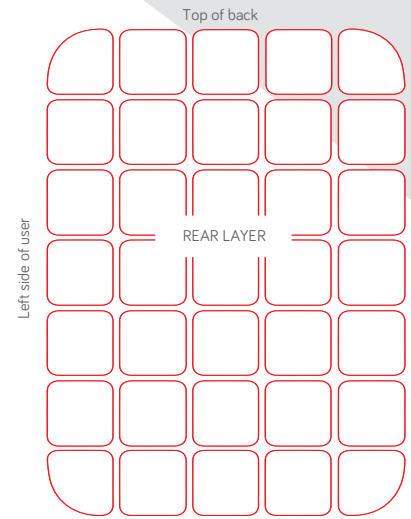
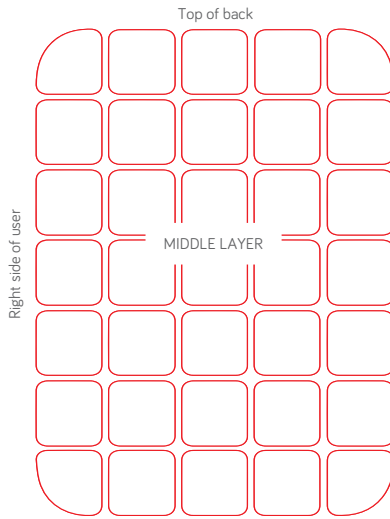
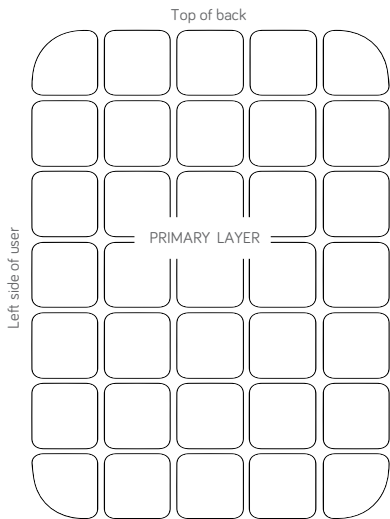

EXAMPLE

Example of how to use the back support contouring positioning chart:

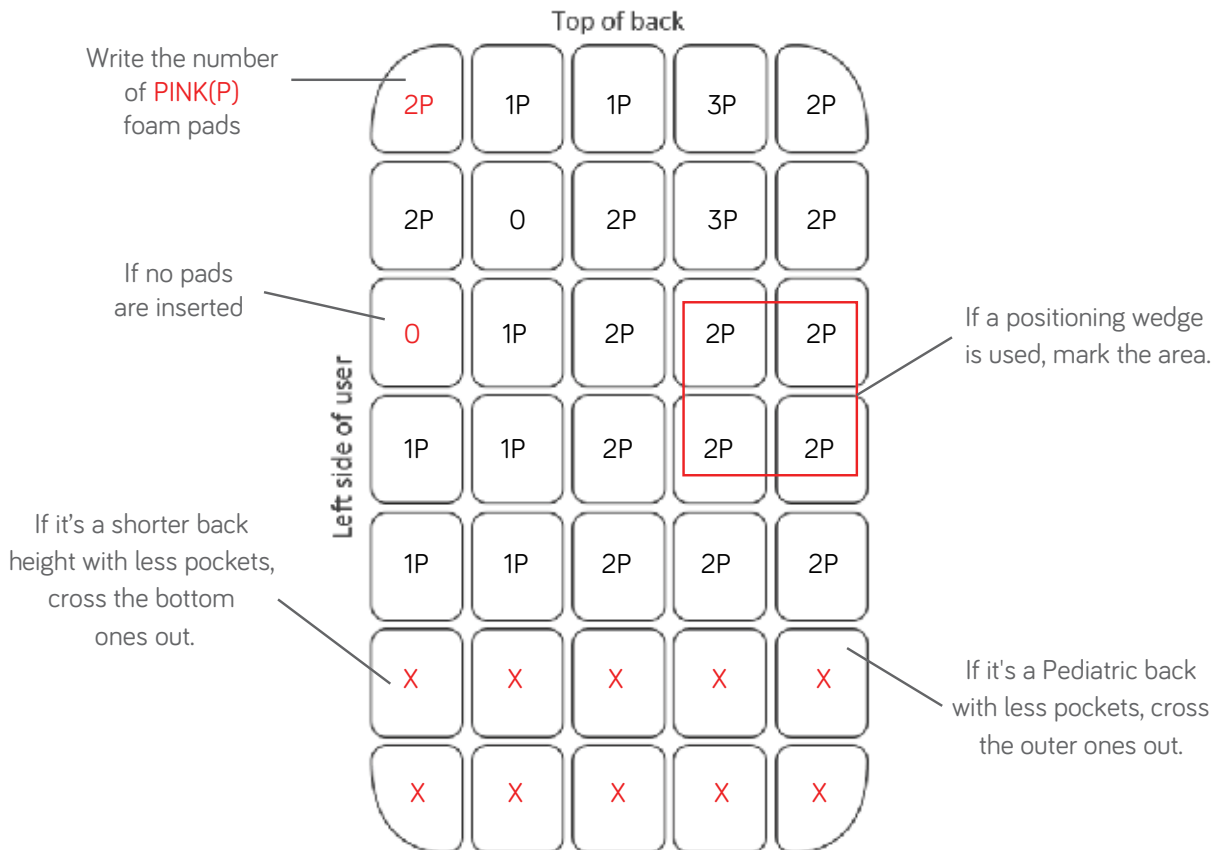

SuperShape™ Back Support

SuperShape provides an extra supportive wheelchair back solution with Shape Technology for contouring to provide postural integrity, pressure relief and comfort. Successfully meets individual trunk shapes of users with complex postural needs. SuperShape is a seating system that can be fitted and changed anywhere and at any time.

CLINICAL

Designed for the individual who:

- Has complex postural needs
- Has significant spinal or trunk asymmetries
- Has protruding skeletal prominences
- Risks skin breakdown and has pressure care requirements
- Requires greater immersion into back support for stability and comfort
- Requires torso pain reduction

FUNCTIONAL BENEFITS

- Expansion fabric cover that allows all kind of contouring without compromising skin protection
- Comfortable pressure reducing foam surface layer to absorb bony prominences
- Triple-layered cube contouring cell system provides configurations for a perfect fit and shape for the client
- Customisation to contouring are performed on-the-spot, as many times as you want
- Created as the solution-solver for asymmetrical back postures
- Modular componentry means you can 'mix and match' with different lateral pad options and positioning supports
- Deep contour solution which offers exceptional contact to contoured areas of the body

ACCESSORIES

- Spare outer cover
- Extra positioning wedges
- Lateral supports, head supports - options from Spex range

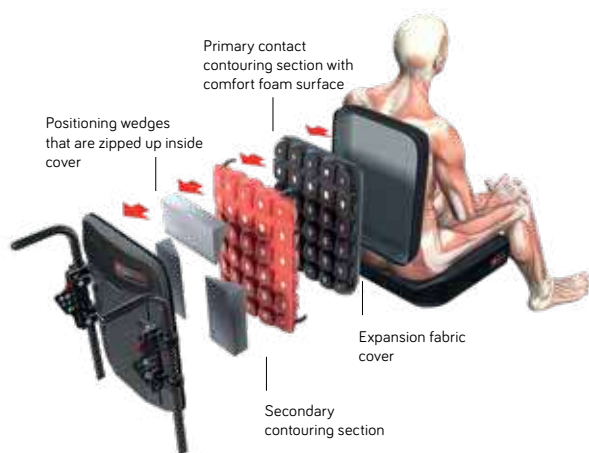

MODERATE NEEDS



Contouring of the cushioning is provided by creating areas of greater or lesser support with adjusting the multiple layered padded pocket cells

COMPLEX NEEDS



On-the-spot contouring allows the patient to adopt their preferred posture for maximum function and comfort.

CUSTOM NEEDS



SuperShape's simple method accomplishes superior seating results by accurately contouring to the complex shapes seen in highly involved clients.



Contouring of the cushioning is essential to apply intimate surface contact to areas of the body which are contoured.

The padded moulding structure is comprised of a three-layered Spex cube contouring substrate.

Looks are deceiving. It looks simple, however the SuperShape has patented, concealed technology!

Best result is achieved by creating areas of greater or lesser support with the adjustment of the multiple layered padded pocket cells.

The front padded surface has a super-soft viscoelastic foam for enhanced trunk immersion and comfort.

SuperShape™ Back Support



HOW SUPERSHAPE WORKS:

- SuperShape back support can be fitted to virtually any wheelchair chassis
- Contouring system comprises of three layers of pockets whereby padding can be increased or decreased to provide different shapes to suit any individual
- Contouring can effectively make an intimate interface contact for even pressure distribution and comfort
- Easily adapted to accommodate complex postural needs such as kyphosis, scoliosis, hyperlordosis
- Angle, depth and height adjustable
- Breathable, washable cover
- Choose from a large range of lateral supports and head supports
- Expansion fabric cover that allows all kinds of contouring without compromising skin protection.

SOLVE COMPLEX CASES:

- SuperShape can adapt to changing needs and provide enough stability for complex and asymmetric postures
- With the large range of Spex support options available, it is possible to start building a seating system using off-the-shelf products and then size and adjust them to achieve a one-of-a-kind fit for complex postural needs' users
- Easy set-up and optimum interfacing with a range of wheelchair chassis
- Wide range of adjustment for growth and changing needs
- Wide range of lateral supports (sizes, models and adjustments)
- Robust and durable
- Comfortable and pressure relief

CREATE DIGNITY WITH BEAUTY

- SuperShape seating solutions can usually be accommodated on chassis up to 2" narrower than conventional moulded seating requires
- See the person, not the seating
- Greater airflow and thermal comfort
- Outer covers spring out to conceal underlying complex contours
- Naturally occurring anti-shear properties



Easily access the contouring system to make changes for complex asymmetric users.



Contouring pockets provide easy adjustment, and positioning will not slip or move once completed.



Triple-layered cube contouring cell system provides configurations for a perfect fit and shape for the client.



2 densities of contouring pads included in every kit to ensure correct personal fitting.

SIZE CHART

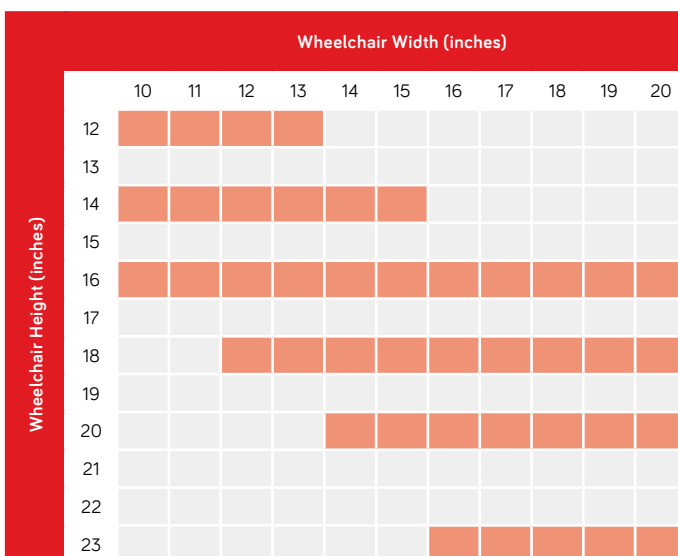

- Red squares are standard sizes.
- Non-standard or custom sizes are available on request.

PRODUCT DETAILS

| Width | Capacity | Product Weight |
|---------|----------------|----------------|
| 10"-15" | 200lbs (90kg) | (16x16) |
| 16"-20" | 300lbs (136kg) | 2.2kg |

- Note: This is the weight of the back support only and does not include the hardware. For hardware weight, refer to page 29.

PRODUCT PERFORMANCE

| | | | | |
|----------------------|-----|-----|-----|---|
| Postural Control | Red | Red | Red | 4 |
| Lateral Stability | Red | Red | Red | 5 |
| Postural Asymmetries | Red | Red | Red | 5 |
| Changing Needs | Red | Red | Red | 5 |
| Pressure Care | Red | Red | Red | 5 |

- Note: This is a guide only and ratings are dependent on correct use of product

Tessellated Positioning Kit

Spex has taken the concept of a tessellation, and applied this method to create contours for seating and positioning. This system can be added to any back support from the Spex range for additional contouring behind the existing upholstery padding.

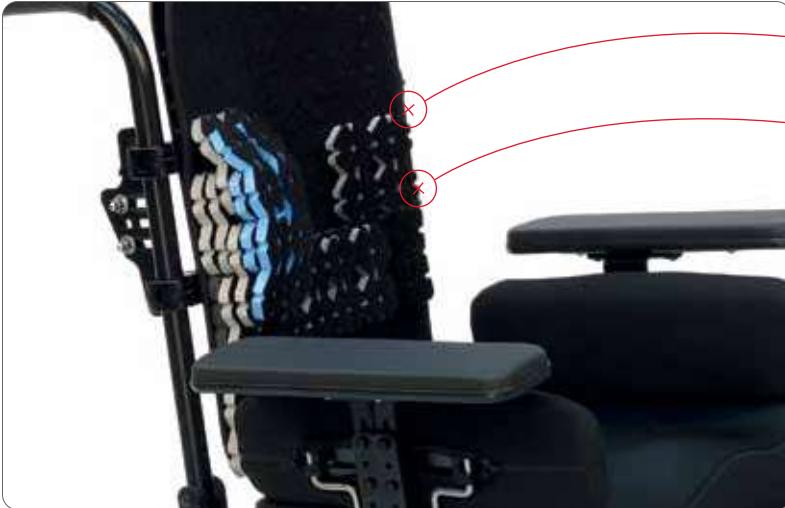

STACK AND CONFIGURE the shapes according to the user's needs

Positioning pack includes a number of different tessellations in **VARYING FOAM DENSITIES**

Developed to be placed **BEHIND THE BACK SUPPORT SQUAB** (in front of the seat shell)



CLINICAL

Tessellated upgrade system can be used:

- To assist clients with mild postural needs when using a standard back support with flat padding
- In all situations where a supportive build-up foundation may be beneficial to assist positioning and comfort
- To improve sitting posture and enhance function (e.g. Creating sacral/lumbar supports)

FUNCTIONAL

- Upgrade Vigour, Mantaray or Spex back supports in order to maximize stability, positioning, and seating tolerance
- Different densities are colour-coded for easy application
Black = Firm density
Grey = Medium density
Blue = Softer density



SIZE CHART

| | | Wheelchair Width (inches) | | | | | | | | | | |
|----------------------------|----|---------------------------|----|----|----|----|----|----|----|----|----|----|
| | | 10 | 11 | 12 | 13 | 14 | 15 | 16 | 17 | 18 | 19 | 20 |
| Wheelchair Height (inches) | 10 | | | | | | | | | | | |
| | 11 | | | | | | | | | | | |
| | 12 | | | | | | | | | | | |
| | 13 | | | | | | | | | | | |
| | 14 | | | | | | | | | | | |
| | 15 | | | | | | | | | | | |
| | 16 | | | | | | | | | | | |
| | 17 | | | | | | | | | | | |
| | 18 | | | | | | | | | | | |
| | 19 | | | | | | | | | | | |
| | 20 | | | | | | | | | | | |
| | 21 | | | | | | | | | | | |
| | 22 | | | | | | | | | | | |
| 23 | | | | | | | | | | | | |

DETAILS

| Product Weight |
|----------------|
| (16x16) |
| 0.6kg |

- Red squares are standard sizes.
- Non-standard or custom sizes are available on request.
- Elements kit only for mounting directly to back shell - 1250-3959-000

NEW Spex® Wheelchair Padding

TRAY PADDING

- Padded surface which can be added to any of the Spex trays for users who prefer a padded top surface
- Protect the elbows and arms from hard tray surface
- Provides a textured surface to prevent objects from sliding around the tray
- Simple Velcro- attachment to tray surface



| Size | Neoprene Padding | CCF Foam Padding |
|---------------|------------------|------------------|
| Thickness | 8 mm | 10 mm |
| Small Tray | 1311-7431-291 | 1311-7431-360 |
| Medium Tray | 1311-7432-291 | 1311-7432-360 |
| Large Tray | 1311-7433-291 | 1311-7433-360 |
| Elbow Padding | 1311-7301-400 | 1311-7302-400 |

TRAVEL TRAY

Trays must be removed when wheelchair users are transported in a vehicle, however many users still require forearm support to enable a safe posture especially when tilt wheelchairs have to be more upright during travel. This unique travel tray option is a good alternative.



- Solid 40mm foam tray core
- Supportive surface assists with forearm propping to maintain a safe posture
- Quick and easy to secure to the wheelchair with straps and buckles
- Black Spextex wipe-down fabric surface

| Size | Small | Medium | Large |
|------|---------------|---------------|---------------|
| CODE | 1311-7441-209 | 1311-7442-209 | 1311-7443-209 |

IMPACT GUARDS

- Reduce risk of pressure in contact points
- Assists with padding the leg hangers for those who have spasms while in the chair



| Hanger Type | 70 degree hangers | 80 and 90 degree hangers |
|-------------|-------------------|--------------------------|
| Code (Pair) | 1415-5360-300 | 1415-5361-300 |

FOOTPLATE PADDING

- Enhanced comfort in the foot area to protect from the hard footplate surface

| Footplate Size | Code |
|----------------|---------------|
| 10"-11" | 1415-5310-300 |
| 12"-13" | 1415-5312-300 |
| 14"-15" | 1415-5314-300 |
| 16"-17" | 1415-5316-300 |
| 18"-22" | 1415-5318-300 |



Lateral Trunk Supports

Spex lateral trunk supports offer adjustability, comfort and positioning. Our anatomical pad design with new full curved Natural-Lateral® surface has been tested for optimum fitting to body shape. The supporting surface of each lateral pad includes a layer of pressure relieving foam for additional protection and comfort.

CLINICAL

- Modular lateral supports provide optimum trunk control whilst improving balance, posture and comfort
- Offset correction can be applied to an asymmetric trunk to bring better trunk alignment for enhanced function

FUNCTIONAL BENEFITS

- Super comfortable pressure-reduction padding for moulding to user shape
- Removable and washable covers
- Brackets are adjustable in all planes: height, width, depth and lateral angle for ultimate trunk orientation
- Spex brings you modular creativity! Mix and match with different pad combinations
- Provide trunk control and stability with the ability to install a lateral in multiple positions on the back support
- Approx. lateral hardware weight is from 0.15 to 0.45 kg, and approx. lateral pad weight is from 0.05 to 0.3 kg

OPTIONS

- Select from Fixed, Standard Swing-Away or Axial® Swing-Away Hardware
- Bracket upgrades available:
 - Cane Mount
 - DeepContour backrest bracket
 - Extension for DeepContour (commonly used with SuperShape backrest)

AXIAL® TECHNOLOGY

Unique swing-away hardware that allows the lateral pad to rotate to correctly support/align to the user's trunk needs.

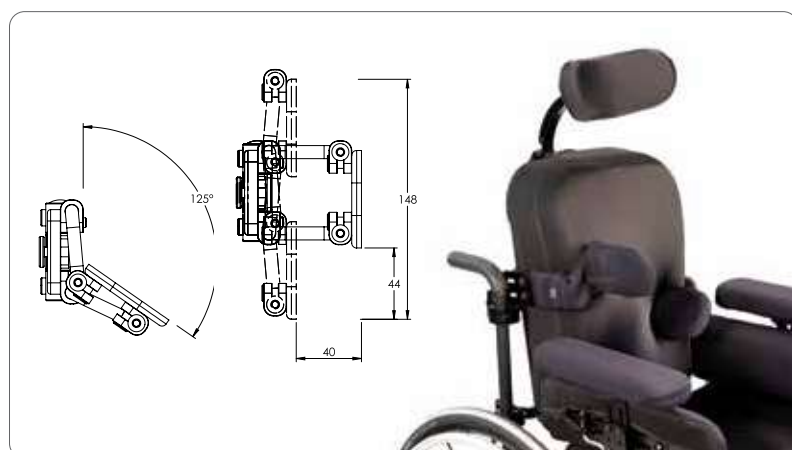

HARDWARE OPTIONS



FIXED

Width and depth adjustable



STANDARD SWING-AWAY

Width and depth adjustable with vertical pivot adjustment.

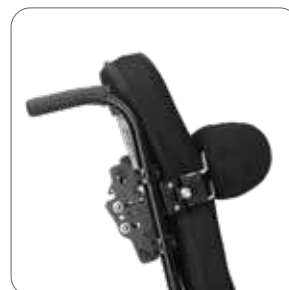

AXIAL SWING-AWAY

Width, depth, and multiple angle adjustable by its rotational system.

Axial technology provides the correct support structure with patented mechanically rotational system.



CANE MOUNT

Mounts directly to wheelchair canes



Anatomical full-curve **NATURAL-LATERAL®** technology for optimum fitting to body shape

Comfort to new levels with **PRESSURE-REDUCING** layer

Huge pad range to provide the exact **SNUG FITTING** comfort that's required (refer Page 50)

FIXED LATERAL HARDWARE

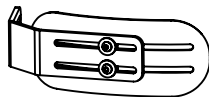

| Options (Add pad, shown on Page 50) | Depth Adjustment | Code |
|-------------------------------------|------------------|---------------|
| Fixed Bracket | 55 mm | 1266-2101-100 |
| Kidz Fixed Bracket | 40 mm | 1266-2111-100 |

AXIAL® LATERAL HARDWARE

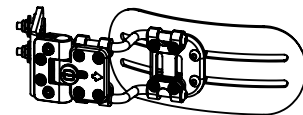

| Options (Add pad, shown on Page 50) | Code |
|-------------------------------------|---------------|
| Axial Hardware | 1266-2301-100 |
| Kidz Axial Hardware | 1266-2311-100 |

SWING-AWAY LATERAL HARDWARE

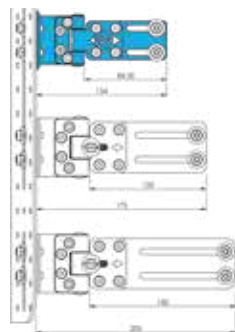
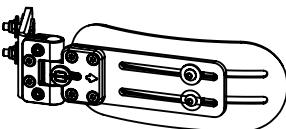

STANDARD

| Options (Add pad, shown on Page 50) | Overall length | Plate Length | Code |
|---------------------------------------|----------------|--------------|---------------|
| Swing-Away, straight bracket | 175 mm | 120 mm | 1266-2201-100 |
| Swing-Away, kidz straight bracket | 134 mm | 85 mm | 1266-2211-100 |
| Swing-Away, straight extended bracket | 205 mm | 150 mm | 1266-2202-100 |

OFFSET

When lateral support is required to sit closer towards the user's trunk to provide support

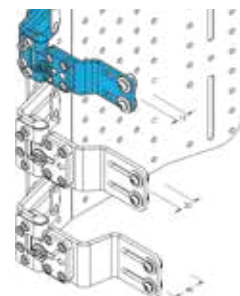

| Options (Add pad, shown on Page 50) | Offset | Code |
|-------------------------------------|--------|---------------|
| Swing-Away, offset bracket | 20 mm | 1266-2203-100 |
| Swing-Away, kidz offset bracket | 15 mm | 1266-2213-100 |
| Swing-Away, offset extended bracket | 40 mm | 1266-2204-100 |

Lateral Support Pads

Anatomical pad design with new full curved Natural-Lateral® surface has been tested for optimum fitting to body shape. Huge lateral support pad range to provide the exact fit required.



STANDARD COVER

- Pictured above. Removable and washable cover option

Comfi-COVER

Exclusive Comfi-Covers are available for all laterals (pictured right):

- Extended padding over mechanism to protect arms from the metal hardware
- Clever release strap for operating the swing away movement
- Easy release for users who have limited hand function and need independent use to open the laterals for transfers

| Pad Style | Size | Pad Height | Pad Depth | Pad & Std Cover | Pad & Comfi-Cover |
|-----------------|------|------------|-----------|-----------------|-------------------|
| Narrow Straight | 0 | 85 mm | 115 mm | 1266-3010-400 | 1266-3010-800 |
| " | 1 | 95 mm | 145 mm | 1266-3011-400 | 1266-3011-800 |
| " | 2 | 95 mm | 180 mm | 1266-3012-400 | 1266-3012-800 |
| " | 3 | 115 mm | 210 mm | 1266-3013-400 | 1266-3013-800 |
| " | 4 | 115 mm | 240 mm | 1266-3014-400 | 1266-3014-800 |
| Narrow Curved | 1 | 95 mm | 145 mm | 1266-3021-400 | 1266-3021-800 |
| " | 2 | 95 mm | 180 mm | 1266-3022-400 | 1266-3022-800 |
| " | 3 | 115 mm | 210 mm | 1266-3023-400 | 1266-3023-800 |
| " | 4 | 115 mm | 240 mm | 1266-3024-400 | 1266-3024-800 |
| Broad | 1 | 105 mm | 130 mm | 1266-3031-400 | 1266-3031-800 |
| " | 2 | 125 mm | 140 mm | 1266-3032-400 | 1266-3032-800 |
| " | 3 | 140 mm | 150 mm | 1266-3033-400 | 1266-3033-800 |
| " | 4 | 160 mm | 155 mm | 1266-3034-400 | 1266-3034-800 |
| " | 5 | 195 mm | 165 mm | 1266-3035-400 | 1266-3035-800 |
| " | 6 | 230 mm | 175 mm | 1266-3036-400 | 1266-3036-800 |

LATERAL PAD OPTIONS



NARROW STRAIGHT

Freedom to move forwards and backwards for functional activities and transfers



NARROW CURVED

Anterior support for increased comfort and spinal extension



BROAD

Provides long trunk support and effective pressure reduction

COMFI-COVER OPTION



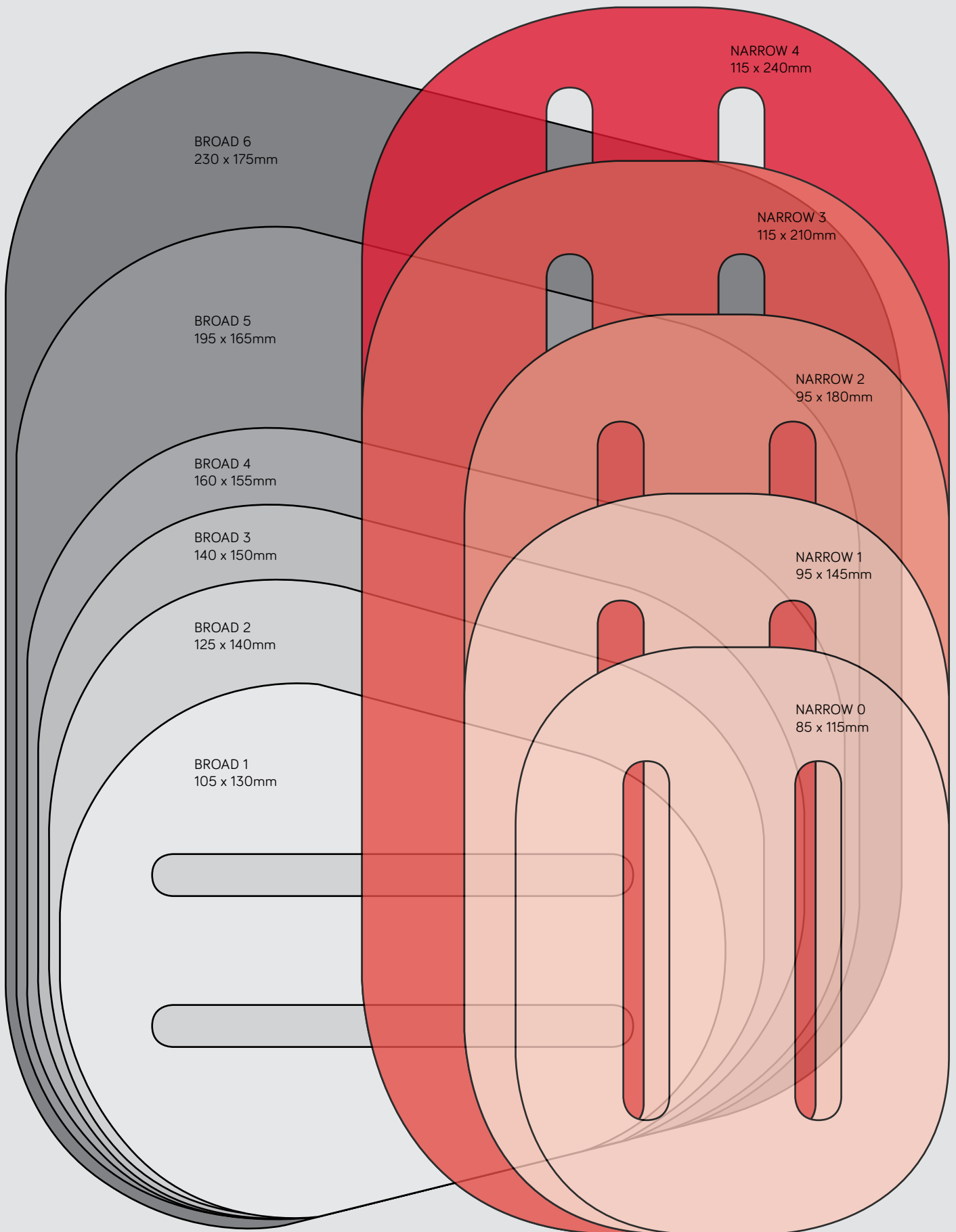

Spex provides the tools to make decisions for faster results, including this lateral pad size guide to scale. When deciding which lateral support pad style and size will suit your clients, place this page against their torso to make an informed decision on the spot!



Transport Certified

WC20

The Spex® Seating System complies with RESNA WC-4:2012, Section 20. Spex is designed only for use with wheelchair frames that have been successfully crash tested to the frontal-impact requirements of RESNA WC-4:2012, Section 19.

Spex Seating Systems must be used on a wheelchair frame that provides four securement points and pelvic-belt anchor points that conform to the requirements of RESNA WC-4:2012, Section 19.

Spex components that are WC20 certified for use during motor vehicle transportation include: Back Support, Grid-Base Seat Pan, Cushion, Thigh & Arm Supports, Trunk Supports and Head Support. The seating system is designed to be occupied when the wheelchair is facing forward in motor vehicles.

The seating system has been designed to accommodate the proper use of vehicle-anchored belt restraints and the ratings of the seating systems with regard to a) ease of properly positioning vehicle-anchored belt restraints on the wheelchair passenger, and b) the degree to which proper positioning of belt restraints can be achieved.

ISO 16840-4

Spex Seating is intended only for use with wheelchair bases tested as part of a complete wheelchair system that conforms to the performance requirements of ISO 7176-19.

Spex Seating Systems must be used on a wheelchair base that provides securement points that conform to the design requirements of ISO 7176-19.

Spex components that are ISO 16840-4 certified for use during motor vehicle transportation include: Back Support, Grid-Base Seat Pan, Cushion, Thigh & Arm Supports, Trunk Supports and Head Support. The seating system is designed to be forward facing when used with a wheelchair base in a motor vehicle.

A wheelchair tie down and occupant restraint system (WTORS) that conforms to the requirements of ISO 10542-1 must be used during wheelchair transportation with this seating system.

When tested in accordance with Annex D of ISO 16840-4 with regard to accommodating vehicle-anchored occupant restraints, Spex Seating achieved an overall score of 16 out of 16, and a rating of A (Good).



Note: Back supports that are lower than the user's shoulder height are not certified and not recommended for transport in a vehicle. e.g. Vigour Lo and Vigour Mid back supports.

Grid-Base Seat Pan

Crash tested and certified for forward facing transportation in a motor vehicle to WC20 & ISO16840-4 standards, the Spex Grid-Base Seat Pan gives the wheelchair chassis the structural foundation to build any configuration of seating.



CLINICAL

- Provides stability and a solid foundation for the cushion to ensure no sag is present when the user is seated
- Allows pressure distribution through over the entire cushion, avoiding pressure in any specific area
- Ensures stability for build up seating cushions

FUNCTIONAL

- Grid hole positions allow multiple uses for mounting support hardware e.g. lateral pelvic/thigh supports, medial thigh support, etc
- One hardware system that is either quick-release or non-removable
- Rear cutout sections around back support cane mounts
- 4 point fixation. Front 2 quick-release pins provide fast sliding removal from the wheelchair
- Designed for both folding and fixed chairs
- Approx. weight is 2.5 kg

| W/C Width | Length | Code | Maximum User Weight | Width adjustment |
|-----------|--------|---------------|---------------------|------------------|
| 10"/11" | 10" | 1007-1012-100 | 90 kg/200 lb | Up to 3.5" |
| 12"/13" | 12" | 1007-1212-100 | 90 kg/200 lb | Up to 3.5" |
| " | 14" | 1007-1214-100 | 90 kg/200 lb | Up to 3.5" |
| 14"/15" | 14" | 1007-1414-100 | 90 kg/200 lb | Up to 3.5" |
| " | 16" | 1007-1416-100 | 90 kg/200 lb | Up to 3.5" |
| 16"/17" | 16" | 1007-1616-100 | 136 kg/300 lb | Up to 3.5" |
| " | 18" | 1007-1618-100 | 136 kg/300 lb | Up to 3.5" |
| 18"/19" | 18" | 1007-1818-100 | 136 kg/300 lb | Up to 3.5" |
| " | 20" | 1007-1820-100 | 136 kg/300 lb | Up to 3.5" |
| 20"/21" | 20" | 1007-2020-100 | 136 kg/300 lb | Up to 3.5" |

FUNCTIONAL BENEFITS



GRID OF HOLES

For ease of installing auxiliary supports

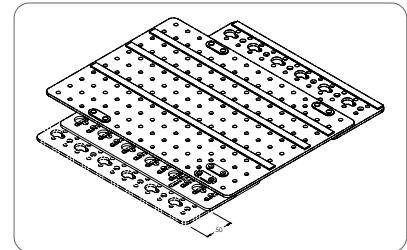

WIDTH-ADJUSTABLE

For future growth



EASY LEVER-LATCH RELEASE SYSTEM

With durable aluminium hardware



SIMPLE REMOVAL

When removed, no hardware remains on the seat pan.

Medial Thigh Support

The Spex® medial thigh support is a wedge shape that can be attached to the front of the wheelchair seat. It should be used to keep the user's legs in the correct position to maintain a neutral pelvis. Provides a comfortable yet firm knee and medial thigh support through a soft padding and removable washable cover.



CLINICAL

- Should be used with clients who experience a variety of movement disorders, fluctuating muscle tone, spasticity or contractures
- Assists to align the heads of the femurs with the acetabulum providing symmetrical hip abduction for proper posture
- Abduction allows equal weight bearing through both ischial tuberosities and thighs, thus permitting better pressure distribution
- Provides a wider, more stable support base for the upper body while limiting contractures and deformities that could interfere with function
- In hip dysplasia cases, luxation or dislocation; provides comfort and reduces pain
- Not to be used as a way to prevent or limit forward sliding. Should be installed clear of the groin area

FUNCTIONAL

- Depth adjustable convenience combined with flip down hardware, which can then pull off the mount to allow an unimpeded transfer (pull-off feature can be locked with a bolt if not required)
- Easy access release hardware which can be mounted to a seat pan
- Huge height range for high profile cushions

| Pad Style | Pad Size | Code | A | B | C | D | E | F |
|---------------|----------|---------------|-----------|--------|--------|-----------|-------|-------|
| Standard | 1 | 1162-1501-000 | 60 mm | 145 mm | 95 mm | 40 mm | 40 mm | 65 mm |
| " | 2 | 1162-1502-000 | 60 mm | 155 mm | 100 mm | 60 mm | 50 mm | 65 mm |
| " | 3 | 1162-1503-000 | 60 mm | 185 mm | 105 mm | 60 mm | 60 mm | 75 mm |
| Axial®-Adjust | 1 | 1162-1601-000 | 70-140 mm | 145 mm | 95 mm | 50-120 mm | 40 mm | 65 mm |
| " | 2 | 1162-1602-000 | 70-140 mm | 155 mm | 100 mm | 60-140 mm | 50 mm | 65 mm |
| " | 3 | 1162-1603-000 | 70-160 mm | 185 mm | 105 mm | 60-140 mm | 60 mm | 75 mm |

PAD OPTIONS

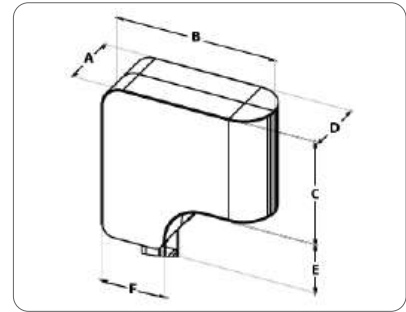

STANDARD PAD

Refer table below for size options.

Approx. weight is from 0.8 to 1.1 kg



AXIAL-ADJUSTABLE PAD

Shown below without cover. Unique expansion fabric cover allows multiple adjustments.

Offset and swivel for asymmetric positions. Infinite adjustments.

Approx. weight is from 0.95 to 1.25 kg

Head Support

Provide adequate neck and head control simply with the Spex head support system. Clever use of twin ball-joints means the head pad can be orientated to where the optimal support is needed.



FUNCTIONAL

- Softly padded foam inner head support, with supple upholstery covers
- Powerful clamp mechanism allows super-quick release and prevents lateral movement
- Extra strong and non-wobbly hardware
- No protruding bar at rear. Carer-friendly design doesn't harm anyone pushing the wheelchair
- Goose-necked stem permits additional fine-tuning, forward and rearward
- Select mechanism from either Standard (20 cm/8" forward range) or Zoom for extended reach (28 cm/11" forward range).
- Approx. head support weight is from 1.2 to 2.05 kg



| Pad Style | Pad Size | Pad Width | Pad Height | Pad & Std Mechanism | Pad & Zoom Mechanism |
|--------------------|----------|-----------|------------|---------------------|----------------------|
| Compact | - | 250 mm | 100 mm | 1270-4131-000 | 1270-4231-000 |
| Square | Small | 200 mm | 160 mm | 1270-4111-000 | 1270-4211-000 |
| " | Large | 240 mm | 200 mm | 1270-4112-000 | 1270-4212-000 |
| Contoured | Small | 285 mm | 115 mm | 1270-4121-000 | 1270-4221-000 |
| " | Large | 340 mm | 165 mm | 1270-4122-000 | 1270-4222-000 |
| Adjustable Lateral | Small | 200 mm | 160 mm | 1270-4141-000 | 1270-4241-000 |
| " | Large | 240 mm | 200 mm | 1270-4142-000 | 1270-4242-000 |
| Comfi | Standard | 270 mm | 150 mm | 1270-4151-000 | 1270-4251-000 |
| | Extended | 270 mm | 165 mm | 1270-4152-000 | 1270-4252-000 |

SUPPORT PAD OPTIONS



COMPACT

Basic, compact head support for clients with good head control.



SQUARE

Unobtrusive yet provides good contact support.



CONTOURED

Offers close lateral and occipital support for clients with reduced head control.



ADJUSTABLE LATERAL

Lateral wings of the head support can be adjusted and locked at the desired position.



COMFI

Posterior head pad with extra support on the sub-occipital area to promote head positioning and encourage alignment

Coloured options available to match cushion/back supports. See page 19 for colours available.

Lateral Thigh Supports

Spex wheelchair thigh supports are transport certified and designed to be installed to the seat pan or seat rail, enabling precise positioning for the user. Various configurations are available including our acclaimed Axial® hardware that enables full support for external hip rotation and wind-swept postures as well as preventing pelvic rotation tendency.

CLINICAL

- Facilitate good thigh alignment and stabilize the sitting posture
- Control hip abduction, moderate external hip rotation, reduces femur and greater trochanter lateral pressure into the wheelchair sideguards by its comfortable pad
- Prevent hip, pelvic and trunk rotation by stabilising the pelvis on the seating system
- In combination with trunk lateral supports, they assist to align the users posture, stabilizing upper body and providing functionality

FUNCTIONAL

- Hardware can be configured various ways to suit different pelvic and thigh patterns
- Arm supports can be upgraded to the hardware if necessary
- Hardware is available in fixed or Axial adjustment. Axial hardware reduces the seat width by 0 to 65 mm each side. Pad is 25 mm thick, and Axial bars allow for up to 40 mm of adjustment
- Washable upholstery covers

Arm Supports

Arm supports provide functional forearm and upper extremity support. Modular system creates flexibility and takes into consideration the individual needs of all kinds of clients. Hardware can be combined with thigh support pads, if required.



CLINICAL

- By having arm supports in the correct position, bearing normal weight on the arm pads will provide better trunk alignment and support which improves posture
- Assist pelvic and trunk stability to reduce or redirect forces that lead to pressure sores
- Correct shoulder girdle stabilising
- In combination with tray table they assist to improve upper body stability essential to accomplishing tasks

FUNCTIONAL

- Spex hardware enables precise positioning of the arm support pads to ensure the user gains the correct positioning for function
- A variety of different hardware options allow specific functions tailored for the user
- Powered chair drive controllers can be easily installed
- Gain accurate width setting and infinite height setting for improved arm placement
- Approx. combo Thigh & Arm Support weight is 1.85 kg per side.

FUNCTIONAL CHOICES FOR THIGH & ARM SUPPORTS



- Quick Release



- Flip-Down. Facilitate easy transfers



- Fixed

ARM SUPPORT CHOICES HEIGHT & ANGLE-ADJUST (PICTURED) OR HEIGHT-ADJUST AVAILABLE



Multiple angle adjustments for precise support.

THIGH SUPPORTS



Support pads orientate for width reduction of pelvic area.



Lateral growth adjustment.



Wind-sweeping ability for correct alignment of pelvis/thighs.



Abduction control within our patented Axial technology to maintain precise support.

SEAT RAIL MOUNT

Option for thigh/arm support hardware. Mounts vertically to the seat rail on most power chairs.

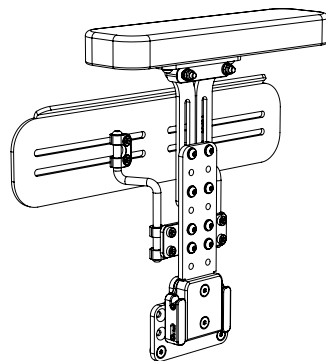

SEAT PAN MOUNT

Option for thigh/arm support hardware. Mounts horizontally to the seat pan of most wheelchairs.

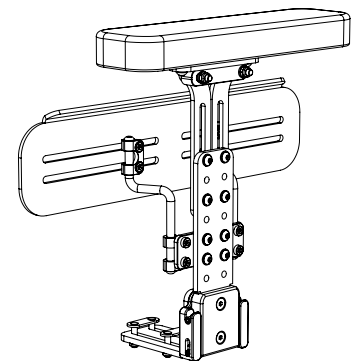

THIGH SUPPORT PADS

| Size | Width | Depth | Code |
|------|--------|--------|---------------|
| 10" | 75 mm | 250 mm | 1156-1010-400 |
| 12" | 80 mm | 300 mm | 1156-1012-400 |
| 14" | 90 mm | 350 mm | 1156-1014-400 |
| 16" | 100 mm | 400 mm | 1156-1016-400 |
| 18" | 100 mm | 430 mm | 1156-1018-400 |
| 20" | 100 mm | 450 mm | 1156-1020-400 |

ARM SUPPORT PADS

| Size | Width | Depth | Code |
|-----------|-------|--------|---------------|
| SML, Slim | 40 mm | 250 mm | 1156-5811-410 |
| MED, Slim | 50 mm | 300 mm | 1156-5812-410 |
| LGE, Slim | 60 mm | 350 mm | 1156-5813-410 |
| SML, Wide | 70 mm | 250 mm | 1156-5821-410 |
| MED, Wide | 80 mm | 300 mm | 1156-5822-410 |
| LGE, Wide | 90 mm | 350 mm | 1156-5823-410 |

Anterior Trunk & Pelvic Positioning Tips

ANTERIOR PELVIC POSITIONING

The Hip Belt is the primary anterior support in seating, as it helps to maintain the stability of the pelvis. Proper placement and use of anterior pelvic supports may prevent sliding into maladaptive, unsafe, or non-functional postures.

- For maximum effect, position the attachment points of the Hip Belt as close to the user as possible.
- Positioning the main (wide) straps below the ASIS reduces the possibility of the pelvis slipping under the belt.
- The selection and set-up of the cushion and backrest influences the position and stability of the pelvis.
- Approx. hip belt weight is from 0.15 to 0.5 kg

ANTERIOR TRUNK POSITIONING

Anterior upper body support is used to maintain spinal alignment over a stable pelvis. Increasing trunk support for proximal stability has been proven to increase upper extremity function.

These are sometimes necessary to maintain an upright trunk and head for functional use of arms, vision, breathing and feeding for individuals who pull or fall forward.

- Attaching the lower straps of the harness to the backrest shell rather than the wheelchair frame provides a more snug fit.
- Shoulder strap guides hold the harness in position over the user's shoulders.
- Approx. harness weight is from 0.25 to 0.55 kg

THE SPEX ADVANTAGE

- Soft comfortable pads offer excellent resilience, water resistance, and **CONFORM TO THE BODY** without creasing
- Durable webbing is 'ridge' woven for **MAXIMUM GRIP** once adjusted
- **TOUGH** Stainless Steel Adjusters
- Attachment hardware included with every Hip Belt allows a multitude of positioning options
- Smooth, soft binding is **COMFORTABLE** against sensitive skin
- Slick pad design reduces coverage to **MINIMISE SWEATING**
- Harness follows **NATURAL CONTOURS** of the body
- **DYNAMIC FABRIC** accommodates movement while maintaining positioning



Anterior Trunk Positioning

Unique harness designs suit a wide scope of requirements for postural restraint and support.



FUNCTIONAL

- Pads follow natural contours of the body, with sleek design to minimise sweating
- Soft edge binding to reduce chafing, while heavy duty webbing will resist the twist
- Maintain and encourage spinal alignment over a stable pelvis

| | Size | Code | Spec (1) | Spec (2) | Spec (3) | W/C Width | Image |
|----------------------|---------------|---------------|----------|----------|----------|-----------|-------|
| H-HARNESS | XSML | 1409-6640-017 | | 27 cm | | 8" - 12" | |
| | SML | 1409-6641-017 | | 30 cm | | 11" - 15" | |
| | MED | 1409-6642-017 | | 36 cm | | 14" - 17" | |
| | LGE | 1409-6643-017 | | 42 cm | | 17" - 20" | |
| | XLGE | 1409-6644-017 | | 48 cm | | 20" + | |
| RETRACTOR HARNESS | SML | 1409-6621-017 | | 32 cm | | 11" - 15" | |
| | MED | 1409-6622-017 | | 38 cm | | 14" - 17" | |
| | LGE | 1409-6623-017 | | 44 cm | | 17" - 20" | |
| | XLGE | 1409-6624-017 | | 50 cm | | 20" + | |
| VEST HARNESS | XSML | 1409-6610-017 | 15 cm | 24 cm | 24 cm | 8" - 12" | |
| | SML | 1409-6611-017 | 20 cm | 32 cm | 32 cm | 11" - 15" | |
| | MED | 1409-6612-017 | 26 cm | 40 cm | 40 cm | 14" - 17" | |
| | LGE | 1409-6613-017 | 30 cm | 48 cm | 48 cm | 17" - 20" | |
| CENTRE-POINT HARNESS | XSML | 1409-6660-017 | 23 cm | 26 cm | 22 cm | 8" - 12" | |
| | SML | 1409-6661-017 | 29 cm | 36 cm | 32 cm | 11" - 15" | |
| | MED | 1409-6662-017 | 34 cm | 40 cm | 36 cm | 14" - 17" | |
| | LGE | 1409-6663-017 | 40 cm | 45 cm | 42 cm | 17" - 20" | |
| XLGE | 1409-6664-017 | 45 cm | 50 cm | 50 cm | 20" + | | |

SHOULDER STRAP GUIDES

Recommended for any harness choice to prevent shoulder straps falling off shoulders. Height adjustable and fit both 1" and 1.5" straps. 1400-6692-000



HARNESS OPTIONS



H-HARNESS

Minimalist option with good adjustment



RETRACTOR HARNESS

Encourages retraction of the shoulders



VEST HARNESS

- Greater coverage across the chest area where support is needed
- Low neck design for safety
- Stomach clearance comfort cutout



CENTREPOINT HARNESS

- Follows natural contours of the body and has clearance for items such as stomach feeding tubes
- Can be independently operated by the user

Anterior Pelvic Positioning

Manufactured with top precision quality, the Spex Hip Belt range caters for a wide range of positioning needs.



FUNCTIONAL

- Specially designed webbing and non-slip attachments
- Comfortable cushioned pads with unique soft edge binding
- Full range available: choose from 2- or 4-point, centre-pull, side-pull, and a range of buckle options and sizes

| Hip Belt Style | X-Small Pad width 30 cm | Small Pad width 36 cm | Medium Pad width 46 cm | Large Pad width 56 cm |
|------------------------------------|---|--------------------------|---------------------------|--------------------------|
| 2 POINT PADDED CENTRE-PULL | 1404-6210- | 1404-6211- | 1405-6212- | 1405-6213- |
| | Select buckle from -027, -028, -026, -025 | | | |
| 2 POINT PADDED DUAL CENTRE-PULL | 1405-6220-027 | 1405-6221-027 | 1405-6222-027 | 1405-6223-027 |
| | Only available with side-release buckle | | | |
| 4 POINT PADDED SIDE-PULL | 1406-6400- | 1406-6401- | 1406-6402- | 1406-6403- |
| | Select buckle from -027, -028, -026, -025 | | | |
| 4 POINT PADDED CENTRE-PULL | 1406-6410- | 1406-6411- | 1406-6412- | 1406-6413- |
| | Select buckle from -027, -028, -026, -025 | | | |
| 4 POINT PADDED DUAL CENTRE-PULL | 1406-6420-027 | 1406-6421-027 | 1406-6422-027 | 1406-6423-027 |
| | Only available with side-release buckle | | | |

BUCKLE OPTIONS



| Side-Release | Centre-Release | Anti-Escape | Pen-Popper |
|---|---|---|--|
| -027 | -028 | -026 | -025 |
| Simple and easy to click together and undo. | Robust design to keep the user positioned and safe. | Prevent users with challenging behaviour from releasing the buckle. | Requires a pen to prod the buckle mechanism to release open. |

HIP BELT OPTIONS



2 POINT CENTRE-PULL

User or carer operated. Tensions at centre of buckle. Suits clients with low muscle tone or weakness.



2 POINT DUAL-CENTRE PULL

User or carer operated. Tensions from both sides at centre of buckle. Suits clients needing greater adjustment. Accommodates clothing/weight changes.



4 POINT SIDE PULL

Carer operated. Tensions from the rear of the pad pulling towards the centre, for more severe needs. Suits clients with high muscle tone.



4 POINT CENTRE PULL

User or carer operated. Tensions at centre of buckle. Suits clients with low muscle tone or weakness.



4 POINT DUAL CENTRE PULL

User or carer operated. Tensions from both sides at centre of buckle. Suits clients needing greater adjustment. Accommodates clothing/weight changes.

Limb Stabilisers

Careful positioning of the feet is critical as it indirectly influences the position of the pelvis and affects the overall stability of the user.

FOOT-FASTS

- Soft comfortable pads contoured for a snug fit
- Buckle fastened and tension adjustable for quick fitting
- Attachment hardware included
- Posterior strap option adds extra stability to the user's foot

| | Small | Medium | Large |
|--|---------------|---------------|---------------|
| FOOT-FASTS | 1401-6161-017 | 1401-6162-017 | 1401-6163-017 |
| FOOT-FASTS WITH POSTERIOR RETAINER STRAP | 1401-6165-017 | 1401-6166-017 | 1401-6167-017 |
| INNER CIRCUMFERENCE | 15-23 cm | 22-30 cm | 26-38 cm |

CALF STRAPS

- Padded with pressure-relieving foam infill
- Velcro attachment
- Soft water resistant pad

| Size | Height | Calf Strap Code | Size | Height | Calf Strap Code |
|------|--------|-----------------|--------|--------|-----------------|
| 10" | 50 mm | 1402-6170-017 | 17" | 90 mm | 1402-6174-017 |
| 12" | 50 mm | 1402-6171-017 | 18" | 110 mm | 1402-6175-017 |
| 14" | 70 mm | 1402-6172-017 | 20" | 130 mm | 1402-6176-017 |
| 16" | 90 mm | 1402-6173-017 | Custom | | 1402-6177-017 |

HEEL LOOPS

- Quality webbing resists twisting
- Low, unobtrusive and secure
- Attachment hardware included
- Allows wheelchair footplates to be folded away without restrictions
- No protruding attachment pins

| | Small | Medium | Large |
|------------|---------------|---------------|---------------|
| HEEL LOOPS | 1403-6181-017 | 1403-6182-017 | 1403-6183-017 |

FOREARM STRAPS

- Buckle fastened
- Adjustable straps
- Can attach with wood screws to wooden arm pads or through existing arm pad attachment points

| | Small | Medium | Large |
|-------------------------|---------------|---------------|---------------|
| SET OF 4 FOREARM STRAPS | 1408-6511-017 | 1408-6512-017 | 1408-6513-017 |
| FOREARM STRAP - 1 ONLY | 1408-6521-017 | 1408-6522-017 | 1408-6523-017 |



Foot-Fasts with Posterior Retainer Strap



Break the mould!



Wheelchair user in her previous custom moulded seating system.

Spex has developed a modular approach to enable the most complex postures to be assessed and fitted with an off-the-shelf seating solution.

In the early beginnings of Medifab, we carved and moulded foam seating systems around the client's shape. This was laborious work and took many fitting sessions to get right. It was difficult to achieve postural

“Spex truly changes lives – therapists included”

outcomes as the clients positioning needs kept changing daily.

Striving for a modular and easier approach, Spex methodology has disrupted the custom moulded seating industry. The patented intuitive shape and contouring technology together with finely adjustable hardware has allowed wheelchair users

with asymmetrical body positions who are typically immersed into a moulded foam seating system to experience the relief of sitting in a seating system that not only still offers a match for their shape, but enhanced comfort, temperature control and the ability to infinitely modify the system after the first set-up.

Spex truly changes lives – therapists and clinicians included as the Spex adjustable system allows carers and therapists to customise Spex to their client's individual postural needs, making daily discomfort a thing of the past.

“Spex methodology has disrupted the custom moulded seating industry”



Contouring the seating system with the patented contouring pockets.



Now fitted with Spex after a single appointment.



Our culture

We are driven by a single-minded purpose – to bring comfort and functionality to people living with disabilities. Every day, we work towards our mission: ‘shaping better lives’. And our values are embedded in everything we do.

Our values



LOYALTY

We're committed to the company, team and every one of our customers.



INTEGRITY

We uphold the strongest moral and ethical principles every day.



VICTORY

We achieve and succeed in everything we do.



ENTHUSIASM

We're passionate about shaping better lives.



SOLUTIONS

We're creative, forward thinking solution-finders.

medifab®

Manufactured by Medifab Ltd

32 Detroit Drive
Rolleston 7675
New Zealand

+64 3 307 9790

solutions@medifab.com

www.spexseating.com



DISTRIBUTED BY:

| US | REP | EC | REP |
|---|-----|--|-----|
| Medicept 200 Homer Ave, Ashland MA 01721, United States Tel: +1-508-231-8842 | | BEO MedConsulting Berlin GmbH Helmholtzstr. 2 D-10587 Berlin, Germany Tel: +49-30-318045-30 | |



Spex_Catalogue_EX_3-20